

Datasheet

SmartLED-IV

45W LED Backlight Converter

IN-54-xxx

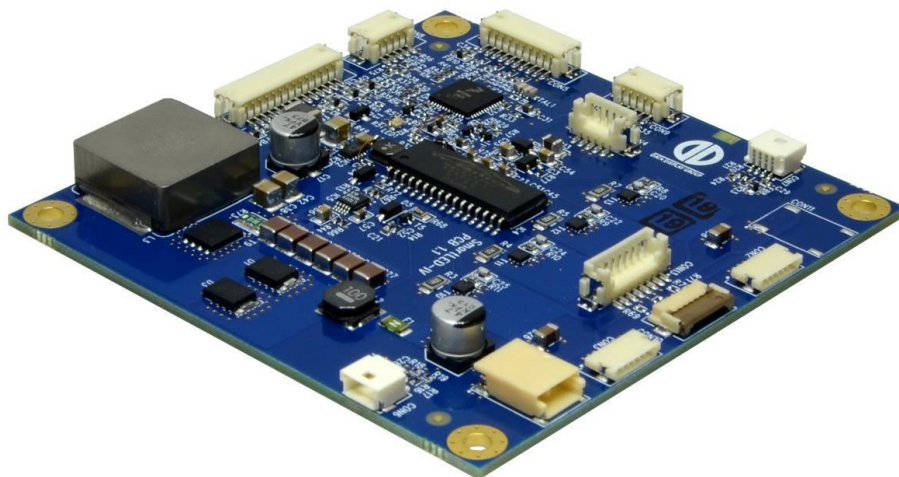

Design EN55022 and EN61000-6-2 oriented

Version 1.0.11

22.06.2017

The information contained in this document has been carefully researched and is, to the best of our knowledge, accurate. However, we assume no liability for any product failures or damages, immediate or consequential, resulting from the use of the information provided herein. Our products are not intended for use in systems in which failures of product could result in personal injury. All trademarks mentioned herein are property of their respective owners. All specifications are subject to change without notice.

Table of Contents

Revision History	3
1. Overview	3
2. Warnings	3
3. General Features	4
4. Hardware Features	5
5. Application Diagram and User Controls	6
6. Absolute Maximum Ratings	7
7. Electrical Specification	8
7.1 Power Sequencing	10
8. Mechanical Specification	11
8.1 Mounting Hole Specification	11
9. Connectors and Switches	12
9.1 Overview	12
9.2 Input Connectors	13
9.2.1 Input Power/Control Connector	13
9.3 Output Connectors	14
9.3.1 LED Rail Connectors	14
9.4 Other Connectors	16
9.4.1 I ² C (Temperature/Light Sensor) connector	16
9.4.2 User Interface/GPIO Connector	16
9.4.3 Master/Slave Connector	17
9.4.4 Serial Interface Connector	17
10. Hardware Information	18
10.1 Ordering Information	18
11. Application Notes	19
11.1 Power Supply Selection	19
12. Accessories	19

Revision History

Date	Rev.No.	Description	Page
17.10.2014	0.1.0	Initial version (ww1)	All
09.02.2015	1.0.0	Reformat, Release version	All
12.03.2015	1.0.1	Changed Picture	1
22.07.2015	1.0.2	Corrected connector type of CON5	8
21.10.2015	1.0.3	Temperature derating spec added	6
23.03.2016	1.0.4	Power Supply Selection Application Notes added Last page updated	16
14.04.2016	1.0.5	FORTEC AG logo added V_{BRITI} replaced by $V_{CONTROL}$	All 8
01.03.2017	1.0.6	Storage Temperature Range updated Input / Output pulse width added Brightness Input / Output Transfer Characteristic added	7 8 9
15.03.2017	1.0.7	Add note Error Flag	8
03.04.2017	1.0.8	Mechanical specifications updated	10
29.05.2017	1.0.9	Electrical specifications updated The obsolete list of supported panels removed Chapter News and Updates removed	8 17 19
13.06.2017	1.0.10	Hardware information updated	17
22.06.2017	1.0.11	Timing diagrams for power sequencing added	10

1. Overview

SmartLED-IV is a 45W output LED backlight converter able to drive up to four rails of high-brightness LEDs. The converter is highly configurable by software and thus can be adapted to a multitude of different applications.

SmartLED-IV is intended as a universal LED Converter to drive LCD panel backlight systems (LED rails) with easy configuration for low and mid quantity sales projects to have a cheaper and/or adaptable product as compared to Mitsubishi (TDK), PowerSystems, CCBR/CDS converter. To compete with these already available products, the SmartLED-IV shall have all the functionality that SmartLED-II and SmartLED-III have. Additionally, SmartLED-IV will allow design of LED rails with higher voltage and higher power.

Less warehouse management and faster kit integration with one adaptable HW.

2. Warnings

Although the SmartLED-IV is using protection circuits for most of its interfaces, it is strongly recommended to adhere to the maximum ratings of SmartLED-IV, outlined in this document.

3. General Features

- Input: 10 – 28V
- Output: 30 – 60V, 30mA – 500mA per channel (rail), total current limited to 1,2A, total power limited to approx. 45W
- Control via analog voltage (0..3.3V or 0..5V) or PWM (100 .. 1000Hz)
- Output PWM synchronized to input, sync signal or free-running with programmable frequency
- I2C for ambient light sensor and temperature sensor(s) (implemented in hardware, firmware support on customer request)
- Additional GPIOs for local control (pushbuttons, sensor pads or potentiometer) of brightness (implemented in hardware, firmware support on customer request)
- Capability to connect multiple boards in a master-slave setup for high-power applications
- Control input for night vision (NVIS) mode (implemented in hardware, firmware support on customer request)
- Error flag to detect failure of power stage or LED rail
- LED brightness control by PWM dimming for stable color temperature; optionally, use current control or combined dimming for brightness control
- Wide dimming range up to 1:15000 (depends on PWM frequency)
- Control characteristic curve can be adapted upon customer request; currently, linear and exponential curve is configurable

Some features require specific firmware support or are mutually exclusive to other features. Please contact your sales partner to discuss possible options or combinations. Features will be configured by different firmware and/or configuration files. For high-volume applications, a version without microprocessor control may be possible as a more economic solution – please contact your sales partner to discuss this as a project-based solution.

Configuration via serial port + software (“SmartLED Rover”) is implemented. Serial port control is also possible, but subject to restrictions to avoid interfering with the protocol used for factory programming/configuration.

4. Hardware Features

High-Efficiency Boost Regulator

- 8 – 28V input voltage range (continuous operation below 12V is subject to output power derating; input current must not exceed 4A continuously)
- Max. 500mA output current per channel (depending on actual rail configuration due to total current and power limit)
- Efficiency $\geq 89\%$, typically 92%

Flexible Microcontroller Control

- On-Board microcontroller handles all input and control signals
- Features are defined by firmware

Daisy Chain for Large LCD Backlighting Systems

- Connect multiple SmartLED converter boards together for powering large LCD LED backlighting systems, 26"+ LCD's
- Capability to combine output channels for high current LED arrays.
- Multiple output channels of SmartLED-IV converter board can be paralleled without additional measures; to connect multiple boards in parallel, a master-slave approach has to be used (additional cable between converter boards is required)

Improved Output Channel Control

- Improved brightness stepping from 0 to 100% brightness
- Exponential control characteristic available as standard and configurable via configuration
- Arbitrary control characteristic in addition to the standard configurable linear and exponential characteristics can be realized in software – please contact your sales partner to discuss possibilities
- Individually control output channels – On/Off and current regulation for different modes, e.g. night vision (NVIS):
 - Channels can be programmed to different max. current levels
 - However, no different current levels possible at the same time
 - Control input – pin shared with sync input – is used to switch over between active channels with their respective current level

Ambient Light Sensor

- Support for ambient light sensor via I2C

Temperature Sensor

- Internal temperature sensor in controller on SmartLED-IV
- External temperature Sensor(s) are supported via I2C
- Two I2C channels are available to allow connection of identical sensors (e.g. for identical sensors on both rails)

Output Fault Checking

- Faulty rails are disabled
- Correctly working rails continue to operate
- Error flag signals faulty rails (short circuit as well as broken wires)

Not all hardware features are already supported by firmware, especially connecting sensors is considered in the hardware but there is no firmware support in place yet. Please discuss possibilities for firmware adaptation with your sales partner.

5. Application Diagram and User Controls

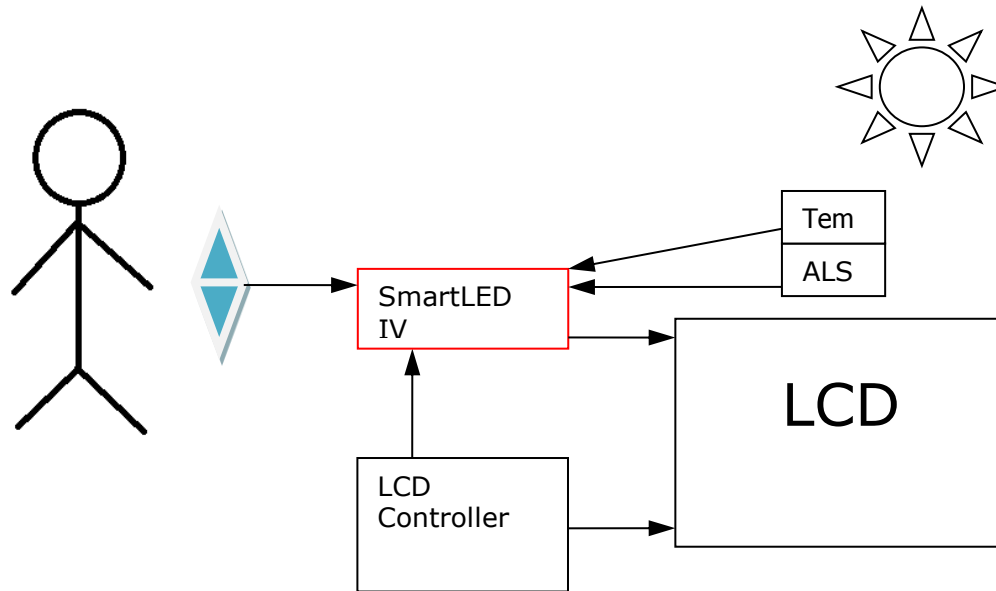

Figure-1: Overview of SmartLED-IV usage (ALS = ambient light sensor)

6. Absolute Maximum Ratings

Permanent damage to the device may occur if maximum values are exceeded!

Item	Symbol	Min.	Max.	Unit	Note
Supply Voltage	V_{in}	-0.3	28	VDC	1
Control Voltages	$V_{ENABLE},$ $V_{CONTROL},$ V_{SYNC}	-1.0	6.0	V	
Storage Temperature	T_{St}	-40	+105	°C	
Operating Temperature	T_{Op}	-30	+80	°C	2

Note (1) Within operating temperature range.

Note (2) In the upper range of T_{Op} total output power as well as the heat dissipation/cooling has to be checked. Forced airflow might be required. The diagram below shows the derating characteristic:

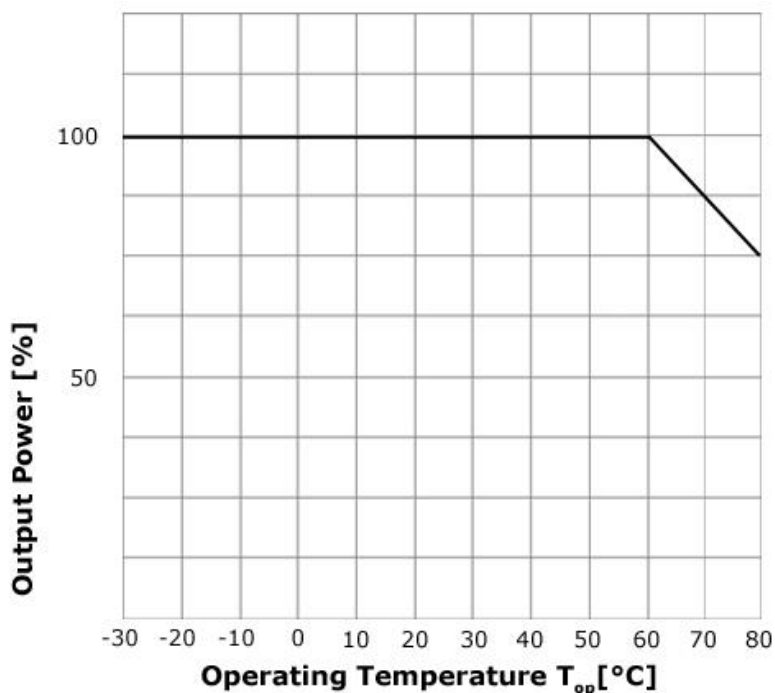

7. Electrical Specification

ITEM	SYMBOL	MIN.	TYP.	MAX.	UNIT	Remarks
Supply Voltage	V_{IN}	8	12	28	V	7)
Efficiency		89	92		%	
Min. ON Level Voltage	$V_{CONTROL}$ (PWM mode), V_{ENABLE}	1.6		5.0	V	
Max. OFF Level Voltage	$V_{CONTROL}$ (PWM mode), V_{ENABLE}	0		0.6	V	
Brightness control voltage	$V_{CONTROL}$ (analog mode)			5	V	IRAIL = max. Note 1)
				3.3	V	
		0			V	IRAIL = min. Note 3)
PWM frequency	F_{PWM}	100	225	1000	Hz	
Dimming	V_{PWMIN}	0		100	%	Note 2), 3)
Input pulse width	T_{PWI}	90			μs	Note 8)
Output pulse width	T_{PWO}	0.6		T_{PWI}	μs	Note 9)
PWM voltage	V_{PWMIN}	0	3.3	5.0	V	
IRAIL LED rail current	I_{RAIL}	30		500	mA	$V_{CONTROL} = \max$ $V_{PWMIN} = 100\%$ Note 5)
Total output current	I_{TOTAL}			1,2	A	Sum of active channels
VRAIL LED rail forward voltage	V_{RAIL}	30		60.0	V	
Total output power	P_{total}	2		45	W	Note 5)
Error Flag	$V_{E,High}$	2.3		3.3	V	10mA max, Note 6, 10)
	$V_{E,Low}$	0			V	Note 6, 10)

Notes:



- 1) To use voltage control of dimming requires alternative firmware or configuration. Brightness control characteristics can be adapted on customer request. Please contact your sales partner for possible options.
- 2) To use external PWM control of dimming requires alternative firmware or configuration. Please refer to Ordering Information section. Leave $V_{CONTROL}$ unconnected, and apply PWM to V_{PWMIN} .
- 3) Error Flag might be unavailable for very low dimming ratio (< 10%, TBD)
- 4) To use sync input requires alternative firmware. Please contact your sales partner for possible options.
- 5) Maximum output current limited by maximum output power depending on rail voltage

- 6) Error flag uses a PNP open-collector output with a 100R current limiting resistor. As such, the pin can not sink any current; the current sourced from this pin must not exceed 10 mA for the minimum output voltage to be achieved
- 7) Maximum continuous input current is 4A; if the converter is to be operated at a lower voltage than 12V continuously, the maximum output power has to be derated accordingly
- 8) Do not fall below that value to prevent flicker.
- 9) Use the Brightness Input / Output Transfer Characteristic feature of ChandlerRover for dimming the brightness to 0nits with smooth transition and achieving the dimming range up to 1:15000@100Hz.
- 10) SmartLED monitors the LED strings to detect LED short-circuit and string open-circuit faults.

When verified, all string faults force the ERROR flag and the red LED active.

As well, only the fault strings are deactivated and remain disabled until toggling ENABLE low and then high.

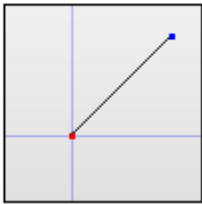
Currently, there is not an ERROR flag connection between SmartLED and Prisma, because Prisma doesn't provide a suitable input to monitor this signal.

Standard settings	Settings for smooth transition
<p>Brightness Input / Output Transfer Characteristic</p> <p>out = in ^ (1 + <input type="text" value="0"/> / 8)</p> 	<p>Brightness Input / Output Transfer Characteristic</p> <p>out = in ^ (1 + <input type="text" value="15"/> / 8)</p> 

7.1 Power Sequencing

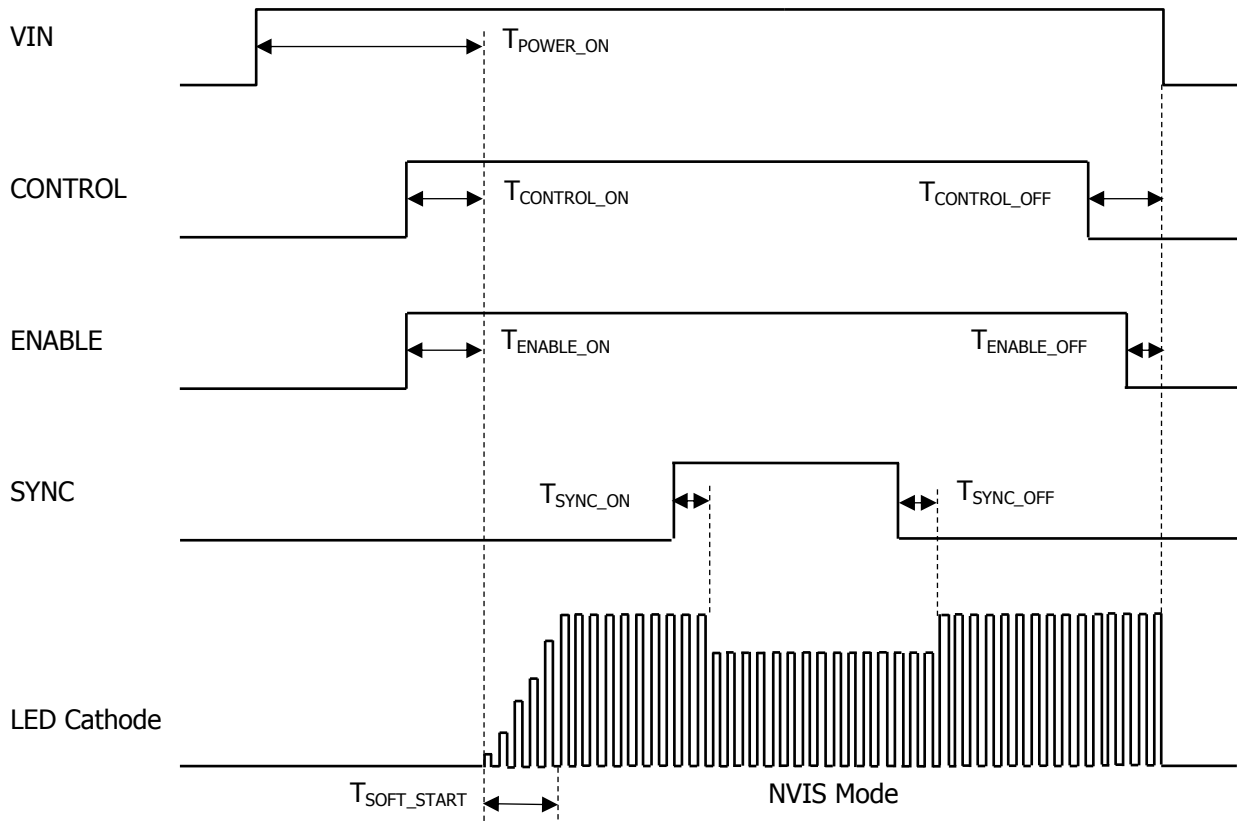

ITEM	SYMBOL	MIN.	TYP.	MAX.	UNIT	Remarks
Power ON time delay	T_{POWER_ON}	1200	1300	1400	ms	$V_{CONTROL} = \max$ $V_{ENABLE} = \max$
Soft Start duration	T_{SOFT_START}	200	300	400	ms	$V_{CONTROL} = \max$ $V_{ENABLE} = \max$
ENABLE ON time delay	T_{ENABLE_ON}	50	100	150	ms	$V_{CONTROL} = \max$
ENABLE OFF time delay	T_{ENABLE_OFF}	5	10	20	ms	$V_{CONTROL} = \max$
CONTROL ON time delay	$T_{CONTROL_ON}$	50	100	150	ms	$V_{ENABLE} = \max$
CONTROL OFF time delay	$T_{CONTROL_OFF}$	20	30	40	ms	$V_{ENABLE} = \max$
SYNC ON/OFF time delay for NVIS control	$T_{SYNC_ON/OFF}$	5	10	20	ms	$V_{CONTROL} = \max$ $V_{ENABLE} = \max$

Note:

The LED Cathode voltage is measured on a shunt resistor connected to the ground and reflects the rail current.

8. Mechanical Specification

ITEM	DESCRIPTION	REMARKS
Length	80 mm	± 0.2 mm
Width	80 mm	± 0.2 mm
Height (top side)	7 mm	± 0.2 mm
Height (PCB)	1.6 mm	± 0.1 mm
Height (bottom side)	0 mm	No components or wires on bottom side
Weight	42 g	

8.1 Mounting Hole Specification

ITEM	DESCRIPTION	REMARKS
Quantity	4	
Inner Diameter	3.2 mm	± 0.1 mm
Outer Diameter	6.8 mm	± 0.1 mm
Copper Plating	0.035 mm	± 0.01 mm
Gold Finish	0.05 µm	± 0.02 µm

The mechanical layout is made similar to current SmartLED-III connector placement, but due to the higher power additional board space for cooling is needed.

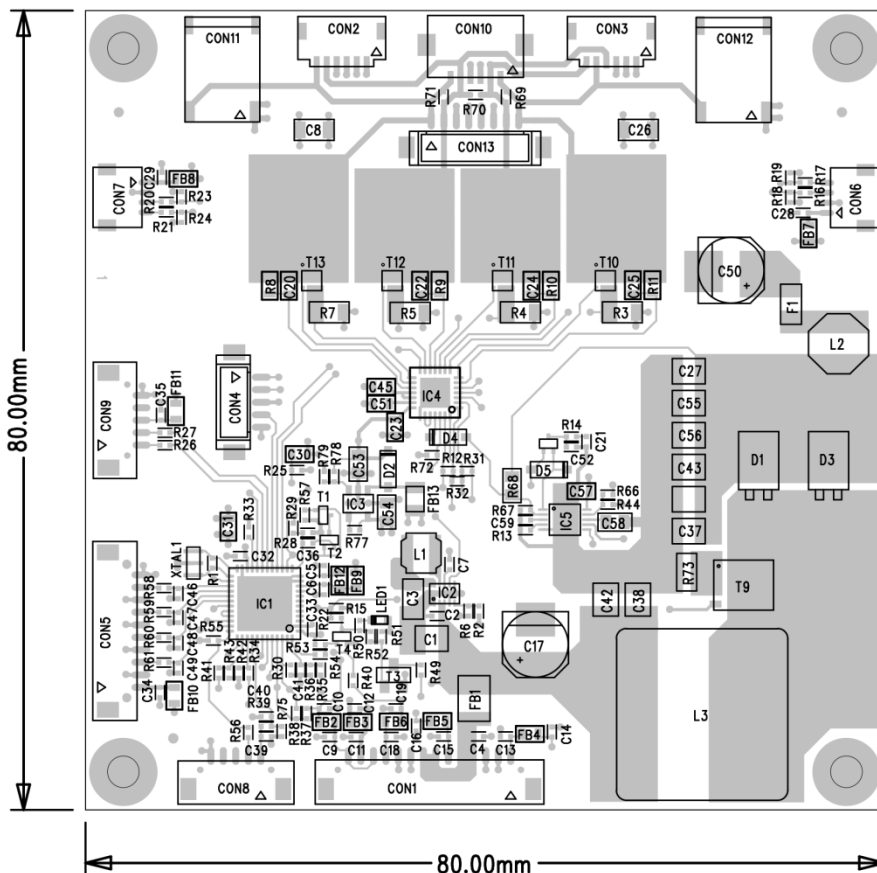

9. Connectors and Switches

The drawing above shows the input and output interfaces of the SmartLED-IV. The design is implemented as a single printed circuit board.

9.1 Overview

CON	DESCRIPTION	TYPE	MANUFACTURER	Notes
CON1	Power supply and control	DF13-14P-1.25H	Hirose	
CON2	Rail 2-4 output	SM06B-SHLS-TF	JST	
CON3	Rail 1-3 output	SM06B-SHLS-TF	JST	
CON4	Factory Programming/Debug	DF13-5P-1.25V	Hirose	
CON5	GPIO / User Interface	DF13-10P-1.25H	Hirose	
CON6	I ² C-0	501331-0407	Molex	
CON7	I ² C-1	501331-0407	Molex	
CON8	Master / Slave	DF13-5P-1.25H	Hirose	
CON9	Serial interface	DF13-5P-1.25H	Hirose	
CON10	Rail 1-4 output	FH12-6S-1SH	Molex	
CON11	Rail 4 output	SM02B-BHSS-1-TB	JST	Assembled only on request
CON12	Rail 1 output	SM02B-BHSS-1-TB	JST	
CON13	Rail 1-4 output	DF13-8P-1.25V	Hirose	

9.2 Input Connectors

9.2.1 Input Power/Control Connector

Location: CON1
 Connector used: DF13-14P-1.25H (20) (Hirose)
 Mating housing: DF13-14S-1.25C (Hirose)
 Function:

Pin No.	Symbol	Function	Note
1	ERROR	ERROR Flag (high = Error)	
2	GND	Power return	
3	GND	Power return	
4	VIN	+12VDC input power	
5	VIN	+12VDC input power	
6	SYNC	External Sync input / NVIS mode select	2
7	VIN	+12VDC input power	
8	VIN	+12VDC input power	
9	GND	Power return	
10	GND	Power return	
11	ENABLE	On/Off control	
12	CONTROL	Brightness control voltage (0-5VDC or PWM)	1
13	+3.3V	Power output	3
14	CONTROL	Brightness control voltage (0-5VDC or PWM)	1

Notes:

- 1) To use voltage or PWM control of dimming requires alternative firmware. Please contact your sales partner for specific information about possible options. Pins 12 and 14 are connected internally but kept for backwards compatibility.
- 2) To use sync input or NVIS mode feature requires alternative firmware. Please contact your sales partner for possible options.
- 3) Output power for supply of analog dimming potentiometer; kept for compatibility, use of GPIO/User Interface for new designs is recommended.

9.3 Output Connectors

9.3.1 LED Rail Connectors

Location: CON13
Connectors used: Hirose DF13-8P-1.25V
Mating housing: Hirose DF13-8S-1.25C
Function:

Pin No.	Symbol	Function
1		LED Cathode Rail 4
2		LED Cathode Rail 3
3		LED Common Anode
4		LED Common Anode
5		LED Common Anode
6		LED Common Anode
7		LED Cathode Rail 2
8		LED Cathode Rail 1

Location: CON10
Connectors used: Hirose FH12-6S-1SH
Mating housing: none (FFC Connector, 6-pin, 1 mm pitch)
Function:

Pin No.	Symbol	Function
1		LED Cathode Rail 1
2		LED Cathode Rail 2
3		LED Common Anode
4		LED Common Anode
5		LED Cathode Rail 3
6		LED Cathode Rail 4

Location: CON11
Connectors used: JST SM02B-BHSS-1-TB
Mating housing: JST BHSR-02VS-01(N)
Function:

Pin No.	Symbol	Function
1		LED Anode
2		LED Cathode Rail 4

Location: CON12
Connectors used: JST SM02B-BHSS-1-TB
Mating housing: JST BHSR-02VS-01(N)
Function:

Pin No.	Symbol	Function
1		LED Anode
2		LED Cathode Rail 1

Location: CON2
Connectors used: JST SM06B-SHLS-TF

Mating housing: JST SHLP-06V-S-B
Function:

Pin No.	Symbol	Function
1		LED Common Anode
2		LED Common Anode
3		LED Common Anode
4		LED Cathode Rail 2
5		LED Cathode Rail 3
6		LED Cathode Rail 4

Location: CON3
Connectors used: JST SM06B-SHLS-TF
Mating housing: JST SHLP-06V-S-B
Function:

Pin No.	Symbol	Function
1		LED Common Anode
2		LED Common Anode
3		LED Common Anode
4		LED Cathode Rail 3
5		LED Cathode Rail 1
6		LED Cathode Rail 2

Outputs can be paralleled using cable adapter or as an assembly option for high-current applications

9.4 Other Connectors

9.4.1 I²C (Temperature/Light Sensor) connector

Location: CON6, CON7
 Connector used: 501568-0407 (Molex)
 Mating housing: 501330-0400
 Function:

Pin No.	Symbol	Function
1	+3.3V	Sensor Supply
2	GND	Ground
3	SCL	clock
4	SDA	data

Two separate I²C channels are used to allow two identical temperature sensors (e.g. mounted on the LED rails) to be used without the need for address selection. Please contact your sales partner for possible firmware modifications to use an ambient light or temperature sensor.

9.4.2 User Interface/GPIO Connector

GPIO pulled out externally via connector to allow for brightness adjustment using external controls.

GPIO pins can be used for keypad (push button or sensor key) as well as analog input for potentiometer. 3.3V supply for potentiometer or external logic is available on user interface connector. Each GPIO pin can be individually configured as a digital GPIO, A/D converter input (ADC) or touch sensing input (TSI). Standard firmware does not include support for this connector; please contact your sales partner for possible options.

Location: CON5
 Connector used: DF13-10P-1.25H (20) (Hirose)
 Mating housing: DF13-10S-1.25C (Hirose)
 Function:

Pin No.	Symbol	Function	Note
1	V3.3V	+3.3VDC output power	1)
2	GND	Power return/shield	
3	GPIO1	GPIO/ADC/TSI	2)
4	GND	Power return/shield	
5	GPIO2	GPIO/ADC/TSI	2)
6	GND	Power return/shield	
7	GPIO3	GPIO/ADC/TSI	2)
8	GND	Power return/shield	
9	GPIO4	GPIO/ADC/TSI	2)
10	GND	Power return/shield	

Notes:

- 1) Maximum current drawn 300mA
- 2) Pin function is software defined; contact your sales partner for possible options

9.4.3 Master/Slave Connector

The master/slave connector is intended to connect and synchronise multiple SmartLED-IV converters for high power applications. Additionally, the GPIO pin present on this connector may be used as an alternative enable input by configuration option.

Location: CON8
 Connector used: DF13-5P-1.25H (20) (Hirose)
 Mating housing: DF13-5S-1.25C (Hirose)
 Function:

Pin No.	Symbol	Function	Note
1	PWM	PWM signal from master to slave	
2	GPIO	General Purpose Input/Output	1)
3	NC	No Connection	
4	NC	No Connection	
5	GND	Ground/Shield	

Notes:

1) This pin can be used as an alternative enable input via configuration option

9.4.4 Serial Interface Connector

The serial interface connector is used for factory programming and can also be used for field firmware or configuration upgrade. The signals are 3,3V TTL/CMOS level. For special applications, a serial control channel can also be implemented in firmware upon request. Please contact your sales partner to discuss further options.

Location: CON9
 Connector used: DF13-5P-1.25H (20) (Hirose)
 Mating housing: DF13-5S-1.25C (Hirose)
 Function:

Pin No.	Symbol	Function	Note
1	TXD	Transmit data from SmartLED-IV	1)
2	RXD	Receive Data to SmartLED-IV	1)
3	+3,3V	3,3V power supply for e.g. level converter	
4	NC	No Connection	
5	GND	Ground/Shield	

Notes:

1) 3,3V TTL/CMOS signal level.

10. Hardware Information

The SmartLED-IV can support single, dual, triple and quad rails at a voltage/current rating of 30 – 60 V at 30 – 500 mA per rail. The total output current must not exceed 1,2A and the total output power must not exceed 45 Watts, however!

Output channels can be combined by connecting in parallel. In master-slave mode, also outputs of multiple boards can be connected in parallel to combine output power.

Connector Types:

#	Connector Types	Adapter Cable	Notes
1	FFC 06PIN 1mm Pitch	KA-40-033	
2	JST SLHP-10V-S-B	KA-25-010	
3	JST SLHP-06V-S-B	KA-25-011	
4	JST SM06B-SHLS-TF	N/R	
5	JST SM02B-BHSS-1-TB	KA-25-009	
6	JOINT TECH A1024HA-06PN	tbd	

Notes: 1) cable adapter required

2) two converters in master-slave configuration required

10.1 Ordering Information

Part Number	Description	Operating Temperature Range	Note
ZU-09-030	SmartLED-IV-A Converter BaseBoard	-30°C..+80°C	1

Note 1:

Dimming method: PWM = Frequency 100Hz–1000Hz, Duty 0% min. Brightness - 100% max. Brightness
Signal level 3,3V or 5V

Analog_3,3V = 0V min. Brightness – 3,3V max. Brightness

Analog_5V = 0V min. Brightness – 5V max. Brightness

Analog_3,3V/Reverse = 3,3V min. Brightness – 0V max. Brightness

Analog_5V/Reverse = 5V min. Brightness – 0V max. Brightness

Supply voltage: Typical supply voltage 12V or 24V (absolute min. 8V – absolute max. 28V)

Input Cable: KA-20-100 Converter cable Prisma to SmartLED-IV 500mm

11. Application Notes

A combination of two different rail types is possible for NVIS applications; the active rail and corresponding current is selected via means of a digital trigger input, e.g.:

Trigger	Channel	Setting	Remarks
Low (0V)	1, 2	On, 200mA	Normal mode
	3, 4	Off	
High (3.3V)	1, 2	Off	NVIS mode
	3, 4	On, 30mA	

11.1 Power Supply Selection

Using of grounded power supplies like Lite-On PA-1061 is necessary for safety and good EMC characteristics.

An isolated power supply can help in mitigating the ground loops and reducing the visual artefacts like water fall noise, caused by sourcing via VGA input.

To prevent such visual artefacts, using of two separated grounded power supplies for the scaler board and the SmartLED-IV is recommended.

12. Accessories

- Input Cable KA-20-100 for connecting to a standard Prisma Board
- Adaptor Cable (panel/rail specific)
- Programming Interface for firmware update or configuration IF-370
- Sensors (ALS, Temperature Sensors): upon request

Our company network supports you worldwide with offices in Germany, Austria, Switzerland, Great Britain and the USA. For more information please contact:

Headquarters

Germany



FORTEC Elektronik AG

Lechwiesenstr. 9
86899 Landsberg am Lech

Phone: +49 8191 91172-0
E-Mail: sales@forteca.de
Internet: www.forteca.de

Fortec Group Members

Austria



FORTEC Elektronik AG

Office Vienna

Nuschinggasse 12
1230 Wien

Phone: +43 1 8673492-0
E-Mail: office@fortec.at
Internet: www.fortec.at

Germany



Distec GmbH

Augsburger Str. 2b
82110 Germering

Phone: +49 89 894363-0
E-Mail: info@distec.de
Internet: www.distec.de

Switzerland



ALTRAC AG

Bahnhofstraße 3
5436 Würenlos

Phone: +41 44 7446111
E-Mail: info@altrac.ch
Internet: www.altrac.ch

United Kingdom



Display Technology Ltd.

5 The Oaks Business Village
Revenge Road, Lordswood
Chatham, Kent, ME5 8LF

Phone: +44 1634 627255
E-Mail: info@displaytechnology.co.uk
Internet: www.displaytechnology.co.uk

USA



Apollo Display Technologies, Corp.

87 Raynor Avenue,
Unit 1 Ronkonkoma,
NY 11779

Phone: +1 631 5804360
E-Mail: info@apolloDisplays.com
Internet: www.apolloDisplays.com