



OUR GLOBAL
COMPETENCE
CENTRES

 APOLLO DISPLAY
TECHNOLOGIES



FORTEC
INTEGRATED



FORTEC
UNITED KINGDOM



Manual

Advantech

MIO-5377R

3.5" SBC 13th Gen. Intel® Core™ Processors Raptor Lake-P



The information contained in this document has been carefully researched and is, to the best of our knowledge, accurate. However, we assume no liability for any product failures or damages, immediate or consequential, resulting from the use of the information provided herein. Our products are not intended for use in systems in which failures of product could result in personal injury. All trademarks mentioned herein are property of their respective owners. All specifications are subject to change without notice.



User Manual

MIO-5377

**13th/12th Gen Intel® Core™ P/U
Series Processors (i7/i5/i3/
U300E)
3.5" MI/O Compact SBC**

ADVANTECH

Enabling an Intelligent Planet

Copyright

The documentation and the software included with this product are copyrighted 2022 by Advantech Co., Ltd. All rights are reserved. Advantech Co., Ltd. reserves the right to make improvements in the products described in this manual at any time without notice. No part of this manual may be reproduced, copied, translated, or transmitted in any form or by any means without the prior written permission of Advantech Co., Ltd. Information provided in this manual is intended to be accurate and reliable. However, Advantech Co., Ltd. assumes no responsibility for its use, nor for any infringements of the rights of third parties that may result from its use.

Acknowledgments

Intel[®] is a trademark of Intel[®] Corporation.

AMI is a trademark of American Megatrends, Inc.

IBM, PC, PS/2, and VGA are trademarks of International Business Machines Corporation.

Microsoft Windows[®] and DirectX[®] are registered trademarks of Microsoft Corp.

All other product names or trademarks are properties of their respective owners.

For more information on this and other Advantech products, please visit our website at: <https://www.advantech.com/en>

For technical support and service, please visit our support website at: <https://www.advantech.com/en/support>

This manual is for the MIO-5377.

Product Warranty (2 Years)

Advantech warrants to you, the original purchaser, that each of its products will be free from defects in materials and workmanship for two years from the date of purchase. This warranty does not apply to any products which have been repaired or altered by persons other than repair personnel authorized by Advantech, or which have been subject to misuse, abuse, accident, or improper installation. Advantech assumes no liability under the terms of this warranty as a consequence of such events.

Because of Advantech's high quality-control standards and rigorous testing, most of our customers never need to use our repair service. If an Advantech product is defective, it will be repaired or replaced at no charge during the warranty period. For out-of-warranty repairs, you will be billed according to the cost of replacement materials, service time and freight. Please consult your dealer for more details.

If you think you have a defective product, follow these steps:

1. Collect all the information about the problem encountered. (For example, CPU speed, Advantech products used, other hardware and software used, etc.) Note anything abnormal and list any on-screen messages you get when the problem occurs.
2. Call your dealer and describe the problem. Please have your manual, product, and any helpful information readily available.
3. If your product is diagnosed as defective, obtain a return merchandise authorization (RMA) number from your dealer. This allows us to process your return more quickly.
4. Carefully pack the defective product, a fully-completed Repair and Replacement Order Card, and a photocopy proof of purchase date (such as your sales receipt) in a shippable container. A product returned without proof of the purchase date is not eligible for warranty service.
5. Write the RMA number visibly on the outside of the package and ship it prepaid to your dealer.

Declaration of Conformity

CE

This product has passed the CE test for environmental specifications. Test conditions for passing included the equipment being operated within an industrial enclosure. In order to protect the product from being damaged by electrostatic discharge (ESD) and EMI leakage, we strongly recommend the use of CE-compliant industrial enclosure products.

FCC Class B

This equipment has been tested and found to comply with the limits for a Class B digital device, pursuant to part 15 of the FCC Rules. These limits are designed to provide reasonable protection against harmful interference in a residential installation. This equipment generates, uses and can radiate radio frequency energy and, if not installed and used in accordance with the instructions, may cause harmful interference to radio communications. However, there is no guarantee that interference will not occur in a particular installation. If this equipment does cause harmful interference to radio or television reception, which can be determined by turning the equipment off and on, the user is encouraged to try to correct the interference by one or more of the following measures:

- Reorient or relocate the receiving antenna.
- Increase the separation between the equipment and receiver.
- Connect the equipment into an outlet on a circuit different from that to which the receiver is connected.
- Consult the dealer or an experienced radio/TV technician for help.

FM

This equipment has passed the FM certification. According to the National Fire Protection Association, work sites are classified into different classes, divisions and groups, based on hazard considerations. This equipment is compliant with the specifications of Class I, Division 2, Groups A, B, C, and D indoor hazards.

Technical Support and Assistance

1. Visit the Advantech website at <http://support.advantech.com> where you can find the latest information about the product.
2. Contact your distributor, sales representative, or Advantech's customer service center for technical support if you need additional assistance. Please have the following information ready before you call:
 - Product name and serial number
 - Description of your peripheral attachments
 - Description of your software (operating system, version, application software, etc.)
 - A complete description of the problem
 - The exact wording of any error messages

Packing List

Before setting up the system, check that the items listed below are included and in good condition. If any item does not accord with the table, please contact your dealer immediately.

- 1 x MIO-5377 SBC
- 1 x SATA Cable 30 cm (P/N: 1700006291)
- 1 x SATA Power Cable 35 cm (P/N: 1700031583-01)
- 1 x USB 2.0 Cable 20 cm (P/N: 1700030406-01)
- 1 x Audio Cable 20 cm (P/N: 1700019584-01)
- 2 x COM RS-232/422/485 Cable 20 cm (P/N: 1700030404-01)
- 2 x COM RS-232 Cable 20 cm (P/N: 1700031582-01)
- 1 x Cooler (P/N: 1970005512T001) for TDP 28W CPU or 1 x Heatsink (P/N: 1970005548T001) for TDP 15W CPU
- 1 x Startup Manual (P/N: 2046537701)
- 1 x Screw Kit (3 x screws for M.2 device & 4 x screws and stand-off for SBC)
- 1 x DeviceOn Package
- 1 x McAfee/Acronis Package
- 1 x Jumper Kit (10 x Jumpers)

Optional Accessories

- 1 x MIO-5377 Heat Spreader (P/N: 1970005615T001)

Contents

Chapter 1	General Information	1
1.1	Introduction	2
1.2	Specifications	2
1.3	Block Diagram	5
Chapter 2	Mechanical Specifications	7
2.1	Introduction	8
2.2	Board Layout: Dimensions	8
	Figure 2.1 MIO-5377 Mechanical Diagram (Top Side)	8
	Figure 2.2 MIO-5377 Mechanical Diagram (Bottom Side)	8
	Figure 2.3 MIO-5377 Mechanical Diagram (Coastline)	9
	Figure 2.4 MIO-5377 Mechanical Diagram (with Heatsink)	9
	Figure 2.5 MIO-5377 Mechanical Diagram (with Cooler)	9
	Figure 2.6 MIO-5377 Mechanical Diagram (with Heatspreader)	9
2.3	Quick Installation Guide	10
	Figure 2.7 MIO-5377 Cooler Installation	10
	Figure 2.8 MIO-5377 Heatsink Installation	10
	Figure 2.9 MIO-5377 Heatspreader Installation	10
Chapter 3	Jumpers and Connectors	11
3.1	Jumpers	12
	Table 3.1: Panel Voltage Selection Jumper: VDD1	12
	Table 3.2: AT Mode /Load BIOS Default: J1	12
3.2	Connectors	13
3.3	Locating Connectors	14
3.4	Setting Jumpers	15
	Table 3.3: CAN Bus Internal Connector: CN3	15
	Table 3.4: CAN Bus Internal Connector: CN2	15
	Table 3.5: I2C Internal Connector: CN8	16
	Table 3.6: I2C Internal Connector: CN7	16
	Table 3.7: I2C Internal Connector: CN6	16
	Table 3.8: Panel Inverter Connector: BL1	17
	Table 3.9: Smart FAN Internal Connector: FAN	17
	Table 3.10: LVDS Connector: LVDS1	18
	Table 3.11: USB 2.0 Dual-Port Internal Connector: USB 3	19
	Table 3.12: Audio Internal Connector: AUDIO1	19
	Table 3.13: SATA Power Connector: SATA_P1	20
	Table 3.14: COM-Port Internal Connector 1: COM1	20
	Table 3.15: COM-Port Internal Connector 2: COM2	21
	Table 3.16: COM-Port Internal Connector 3: COM3	21
	Table 3.17: COM Port Internal Connector 4: COM4	22
	Table 3.18: Front Panel Internal Connector: CN4	22
	Table 3.19: GPIO Internal Connector: CN5	23
	Table 3.20: RTC battery Connector: BAT1	23
	Table 3.21: M.2 E-Key Connector: M2_1	24
	Table 3.22: M.2 M-Key Connector: M2_2	26
	Table 3.23: M.2 B-Key Connector: M2_B1	28
Chapter 4	AMI BIOS Setup	31

4.1	Entering Setup	32
4.1.1	Main Setup.....	32
4.1.2	Advanced BIOS Features Setup.....	33
4.1.3	Chipset Configuration	54
4.1.4	Security.....	64
4.1.5	Boot	65
4.1.6	Save & Exit	66

Appendix A **67**

A.1	System I/O Ports.....	68
A.2	DMA Channel Assignments	69
A.3	1st MB Memory Map.....	69
A.4	Interrupt Assignments	69

Chapter 1

General Information

1.1 Introduction

MIO-5377 is powered by 13th/12th Gen Intel® Core™ P/U series processors and offers Advantech embedded software APIs, such as iManager 3.0, SUSI 4.0, and DeviceOn, which were created by Advantech to monitor and control system operation effectively and remotely. Advantech has also validated MIO-5377 with the embedded OS: Windows 10 LTSC and Ubuntu v22.04 LTS, ready for bundled shipment.

MIO-5377 adopts the latest hybrid core processors to engender improvements in CPU processing, graphics, security, and I/O flexibility. MIO-5377 was designed with the latest USB4 for future expansion. With the MIOe-UMXM extension board, MIO-5377 is expandable to accommodate an additional external embedded MXM graphics module to provide extra GPU performance for AI applications.

1.2 Specifications

Platform	Processor	i7-1370PE	i7-1370PRE	i7-1270PE	i7-1365UE	i7-1365URE
	Max. Frequency (P-Core)	4.80 GHz	4.80 GHz	4.5 GHz	4.90 GHz	4.90 GHz
	Base Frequency (P-Core)	1.90 GHz	1.90 GHz	1.8 GHz	1.70 GHz	1.70 GHz
	Core/Thread	6P+8E / 20T	6P+8E / 20T	4P+8E / 16T	2P+8E / 12T	2P+8E / 12T
	Intel® Smart Cache (L3)	24MB	24MB	18MB	12MB	12MB
	CPU TDP	28W	28W	28W	15W	15W
	Chipset	On-package Intel 600 Series Chipset				
	BIOS	AMI UEFI 256Mbit				
Memory	Technology	DDR5-4800				
	Max. Capacity	Up to 64GB				
	IB ECC	No	Yes	No	No	Yes
	Channel/Socket	Dual Channels / 2 sockets				
Graphics	Controller	Intel® Iris® Xe Graphics				
	Max. Frequency	1.40 GHz	1.40 GHz	1.35 GHz	1.30 GHz	1.30 GHz
	Execution Units	96	96	96	96	96
	3D/HW Acceleration	DX12.1, OGL4.6, OCL3.0, HW Encode: H.265/HEVC, H.264, MPEG2, HW Decode: H.265				
Display I/F	LCD	1 x LVDS: Dual Channel 18/24-bit, up to 1920 x 1200				
	HDMI/DP	1 x HDMI 2.0b, up to 4096 x 2160 x 24bpp@60Hz 1 x DP1.4, up to 4096 x 2304 x 36bpp@60Hz				
	Multiple Display	4 simultaneous displays via LVDS + HDMI + DP + USB Type-C Alt. Mode				
Ethernet	Controller	LAN1: Intel i219; LAN2: Intel i226				
	Speed	LAN1: GbE ; LAN2: 2.5GbE				
	TSN (LAN2 only)	No	Yes	No	No	Yes
External I/O	Ethernet	2 x RJ-45				
	HDMI/DP	1 x HDMI, 1 x DP				
	USB Type-C	1 x USB 3.2 Gen.2 x 1 10Gbps, support DisplayPort 1.4 Alt. Mode				
	USB Type-A	4 x USB 3.2 Gen.2 x 1 10Gbps				
	LED	Power status, SATA R/W				
	Power DC-Jack	Optional				
Internal I/O	SATA	1 x SATA Gen.3 6.0Gbps				
	USB4	1 USB4 with USB Type-C, Bandwidth min. 20Gbps, max. 40Gbps, with USB 3.2, Display & PCIe				
	USB 2.0	2				
	COM Port	2 x RS-232/422/485, 2 x RS-232 (4-wire), max. 1Mbps				
	CAN Bus	2 x CAN 2.0				

	Serial Bus	3 x I2C (CN6 is a BOM option for 1 x SMBus by request; First priority is to use CN6; On Windows, CN7 & CN8 are supported by custom BIOS)
	Audio	Realtek ALC888s, Line-in/Line-out/MIC
	GPIO	8-bit general purpose input output I/O
	Inverter	12V/5V/3.3V selectable
	Fan	12V, 1A (4-wire)
	Front Panel Control	Power-on, Reset, Buzzer, SATA LED, CaseOpen
Board Features	Watchdog Timer	65536 level, 0~65535 sec
	TPM	Discrete TPM 2.0, fTPM* support by request
	iManager 3.0	SW API for Hardware Monitor, Smart Fan Control, Brightness Control, I2C, GPIO, WDT
Expansion	M.2 E-Key	1 x E-Key 2230 (PCIe x1, USB 2.0) for Wi-Fi/BT module
	M.2 B-Key	1 x B-Key 3042 (PCIe x1, SATA, USB 2.0) for storage and 4G/LTE module w/ Nano SIM (Default with 3042. **Support for 3052 for 5G module by request.)
	M.2 M-Key	1 x M-Key 2280 (PCIe Gen.4 x4) for NVMe SSD
Power	Supply Voltage	Vin: DC 12V~24V ± 10%; RTC Battery: Lithium 3V/220mAh (*200mAh for extended temp. SKU)
	Connector	ATX 2x2 pin 90D, optional DC-Jack, or ATX 2x2 pin 180D
	Power Management	AT, ATX
Environment	Temperature	Operating: Standard: 0 ~ 60 °C (32 ~ 140 °F); *Extendable to: -40 ~ 85 °C (-40 ~ 185 °F), support with selected SKU Storage: -40 ~ 85 °C (-40 ~ 185 °F)
	Humidity	Operating: 40 °C @ 95% relative humidity, non-condensing Storage: 60 °C @ 95%relative humidity, non-condensing
	Vibration Resistance	3.5 Grms
Certification	EMC	CE, FCC Class B
Mechanical	Dimensions	146 x 102 mm (5.7" x 4")

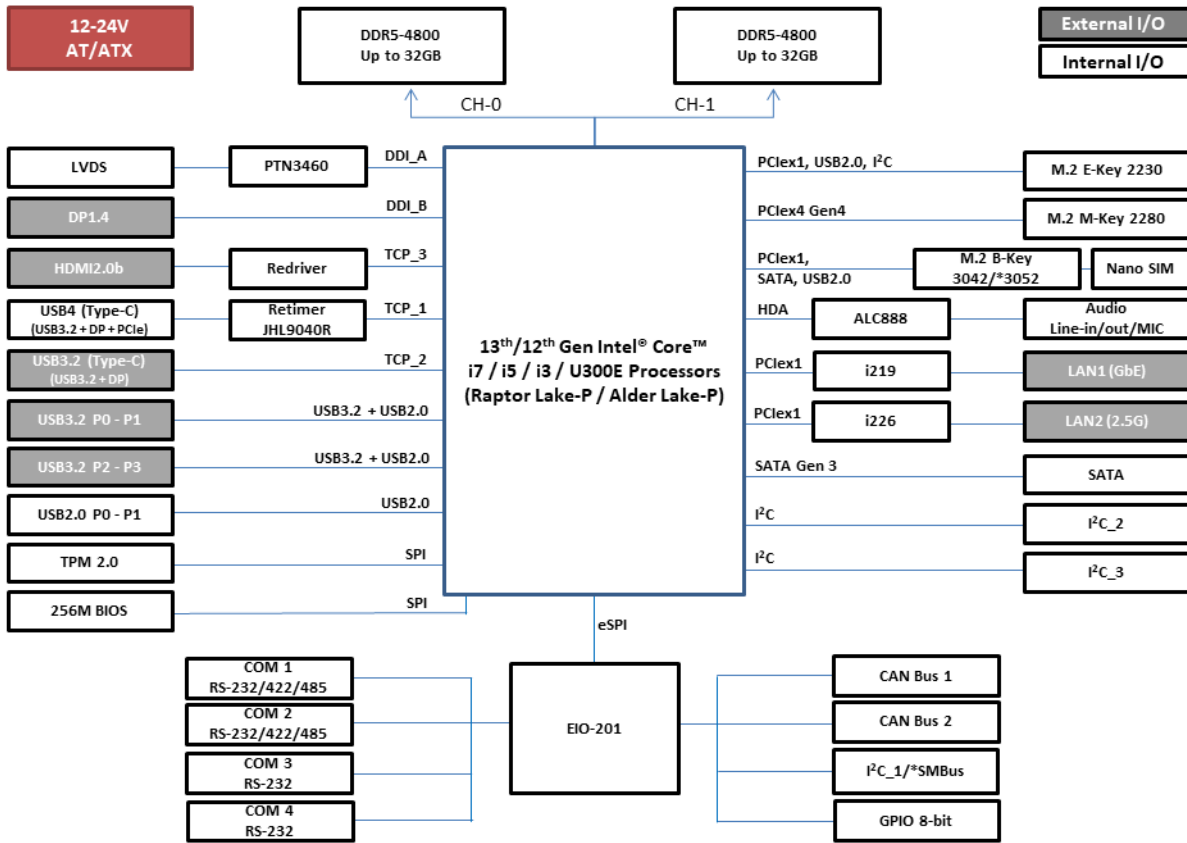
Platform	Processor	i7-1265UE	i5-1345UE	i5-1245UE	i3-1315UE	i3-1215UE	U300E
	Max. Frequency (P-Core)	4.7 GHz	4.6 GHz	4.4 GHz	4.5 GHz	4.4 GHz	4.3 GHz
	Base Frequency (P-Core)	1.7 GHz	1.4 GHz	1.5 GHz	1.2 GHz	1.2 GHz	1.1 GHz
	Core/Thread	2P+8E / 12T	2P+8E / 12T	2P+8E / 12T	2P+4E / 8T	2P+4E / 8T	1P+4E / 8T
	Intel® Smart Cache (L3)	12MB	12MB	12MB	10MB	10MB	10MB
	CPU TDP	15W	15W	15W	15W	15W	15W
	Chipset	On-package Intel 600 Series Chipset					
	BIOS	AMI UEFI 256Mbit					
Memory	Technology	DDR5-4800					
	Max. Capacity	Up to 64GB					
	IB ECC	No	No	No	No	No	No
	Channel/Socket	Dual Channels / 2 sockets					
Graphics	Controller	Intel® Iris® Xe Graphics					
	Max. Frequency	1.25 GHz	1.25 GHz	1.20 GHz	1.20 GHz	1.10 GHz	1.10 GHz
	Execution Units	96	80	80	64	64	48
	3D/HW Acceleration	DX12.1, OGL4.6, OCL3.0, HW Encode: H.265/HEVC, H.264, MPEG2, HW Decode: H.265					
	Multiple Display	4 simultaneous displays via LVDS + HDMI + DP + USB Type-C Alt. Mode					
Display I/F	LCD	1 x LVDS: Dual Channel 18/24-bit, up to 1920 x 1200					
	HDMI/DP	1 x HDMI 2.0b, up to 4096 x 2160 x 24bpp@60Hz 1 x DP1.4, up to 4096 x 2304 x 36bpp@60Hz					
	Multiple Display	4 simultaneous displays via LVDS + HDMI + DP + USB Type-C Alt. Mode					
Ethernet	Controller	LAN1: Intel i219; LAN2: Intel i226					
	Speed	LAN1: GbE ; LAN2: 2.5GbE					
	TSN (LAN2 only)	No	No	No	No	No	No

External I/O	Ethernet	2 x RJ-45	
	HDMI/DP	1 x HDMI, 1 x DP	
	USB Type-C	1 x USB 3.2 Gen.2 x 1 10Gbps, support DisplayPort 1.4 Alt. Mode	
	USB Type-A	4 x USB 3.2 Gen2. x 1 10Gbps	
	LED	Power status, SATA R/W	
	Power DC-Jack	Optional	
Internal I/O	SATA	1 x SATA Gen.3 6.0Gbps	
	USB4	1 USB4 with USB Type-C, Bandwidth min. 20Gbps, max. 40Gbps, with USB 3.2, Display & PCIe	
	USB 2.0	2	
	COM Port	2 x RS-232/422/485, 2 x RS-232 (4-wire), max. 1Mbps	
	CAN Bus	2 x CAN 2.0	
	Serial Bus	3 x I2C (CN6 is a BOM option for 1 x SMBus by request; First priority is to use CN6; On Windows, CN7 & CN8 are supported by custom BIOS)	
	Audio	Realtek ALC888s, Line-in/Line-out/MIC	
	GPIO	8-bit general purpose input output I/O	
	Invertor	12V/5V/3.3V selectable	
	Fan	12V, 1A (4-wire)	
	Front Panel Control	Power-on, Reset, Buzzer, SATA LED, CaseOpen	
	Board Features	Watchdog Timer	65536 level, 0~65535 sec
		TPM	Discrete TPM 2.0, fTPM* support by request
Expansion	iManager 3.0	SW API for Hardware Monitor, Smart Fan Control, Brightness Control, I2C, GPIO, WDT	
	M.2 E-Key	1 x E-Key 2230 (PCIe x1, USB 2.0) for Wi-Fi/BT module	
	M.2 B-Key	1 x B-Key 3042 (PCIe x1, SATA, USB 2.0) for storage and 4G/LTE module w/ Nano SIM (Default with 3042. **Support 3052 for 5G module by request.)	
Power	M.2 M-Key	1 x M-Key 2280 (PCIe Gen.4 x4) for NVMe SSD	
	Supply Voltage	Vin: DC 12V~24V ± 10%; RTC Battery: Lithium 3V/220mAh (*200mAh for extended temp. SKU)	
	Connector Power Management	ATX 2x2 pin 90D, optional DC-Jack, or ATX 2x2 pin 180D AT, ATX	
Environment	Temperature	Operating: Standard: 0 ~ 60 °C (32 ~ 140 °F); *Extendable to: -40 ~ 85 °C (-40 ~ 185 °F), support with selected SKU Storage: -40 ~ 85 °C (-40 ~ 185 °F)	
	Humidity	Operating: 40 °C @ 95% relative humidity, non-condensing Storage: 60 °C @ 95%relative humidity, non-condensing	
	Vibration Resistance	3.5 Grms	
Certification	EMC	CE, FCC Class B	
Mechanical	Dimensions	146 x 102 mm (5.7" x 4")	

* Support by request

** 5G module test with Fibocom FM350 (MediaTek)

1.3 Block Diagram



Chapter 2

Mechanical
Specifications

2.1 Introduction

MI/O is a compact form factor, new-generation SBC designed with a variety of mechanical improvements. This chapter includes board dimensions and assembly instructions for standard thermal solutions.

2.2 Board Layout: Dimensions

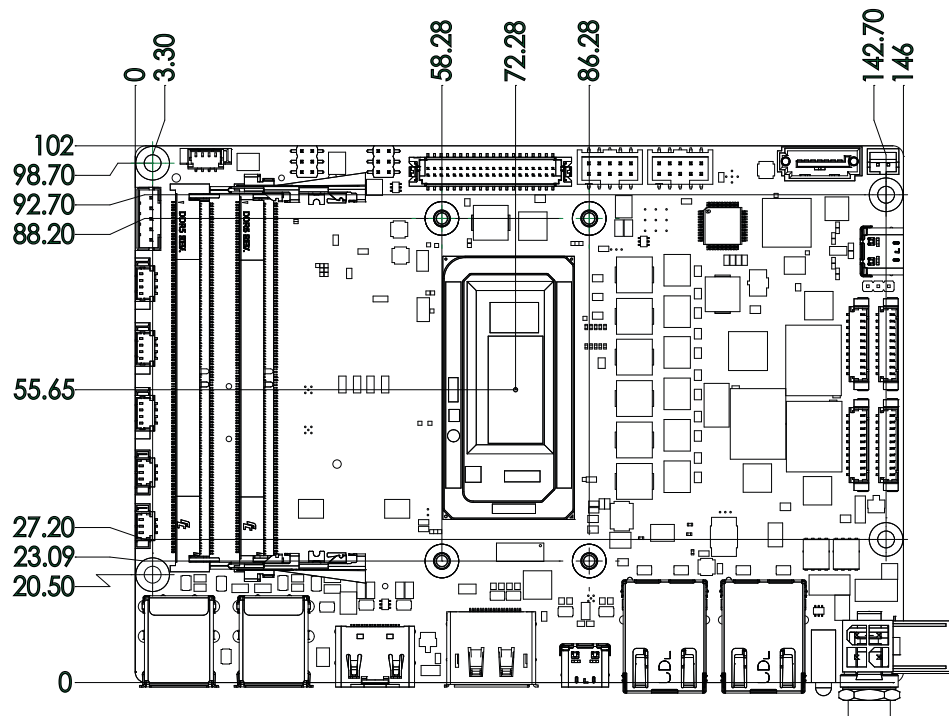


Figure 2.1 MIO-5377 Mechanical Diagram (Top Side)

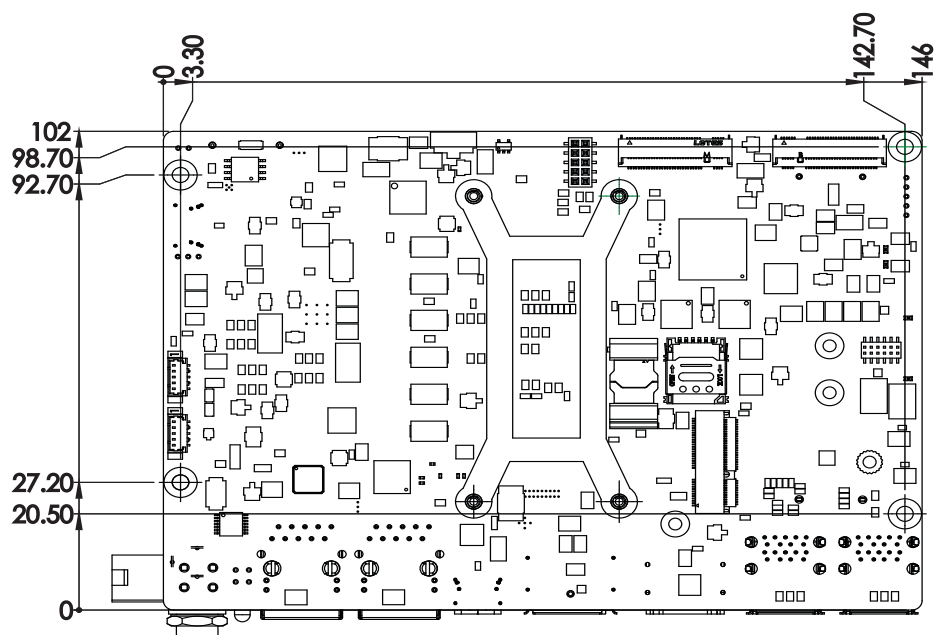


Figure 2.2 MIO-5377 Mechanical Diagram (Bottom Side)

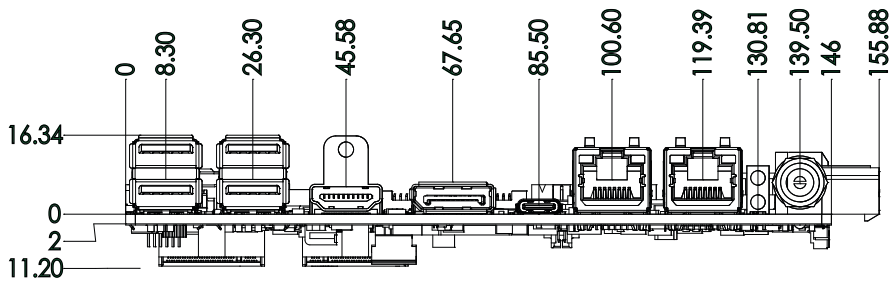


Figure 2.3 MIO-5377 Mechanical Diagram (Coastline)

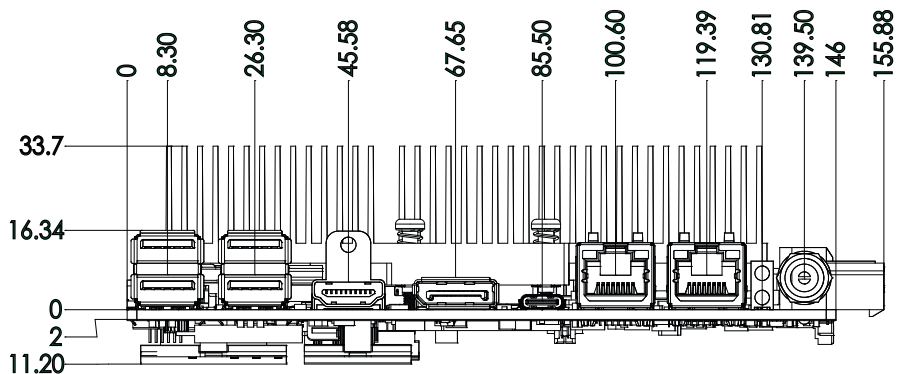


Figure 2.4 MIO-5377 Mechanical Diagram (with Heatsink)

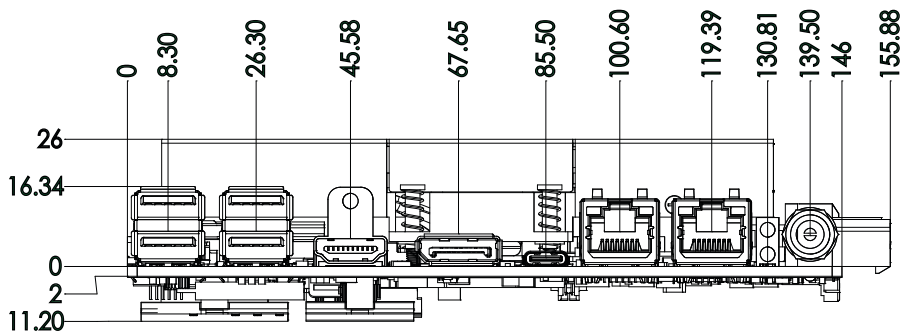


Figure 2.5 MIO-5377 Mechanical Diagram (with Cooler)

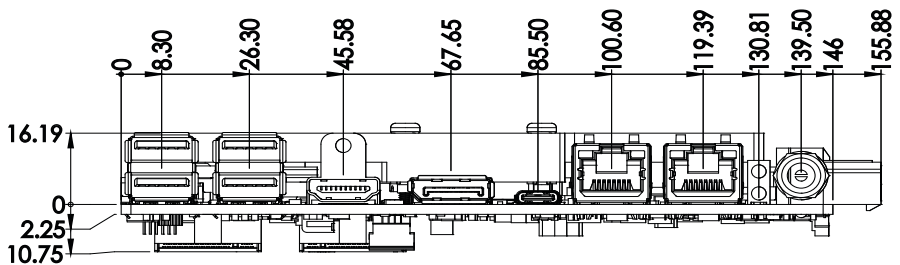


Figure 2.6 MIO-5377 Mechanical Diagram (with Heatspreader)

2.3 Quick Installation Guide

This section introduces the installation of the heatsink which can be found inside a white box inside the package. Please assemble it by following the diagram below. Remember to remove the plastic from the thermal pad before assembly.

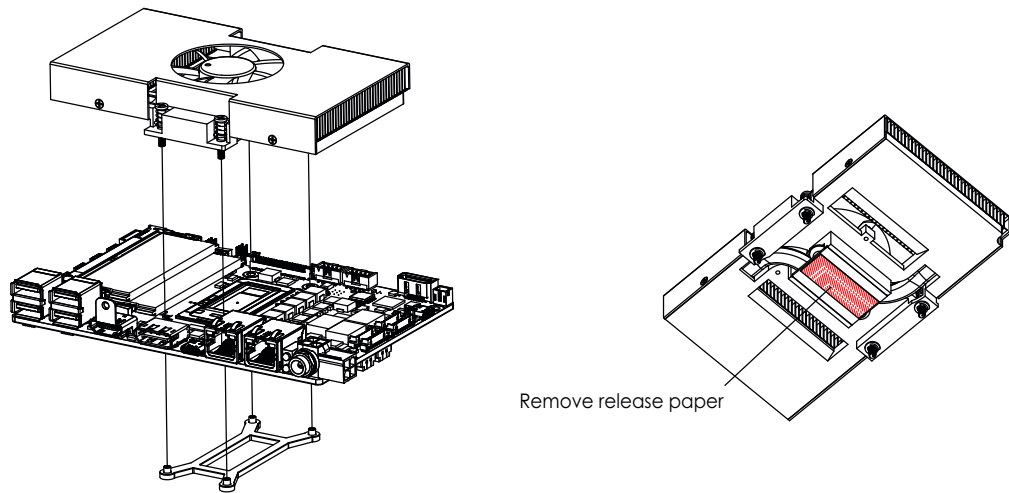


Figure 2.7 MIO-5377 Cooler Installation

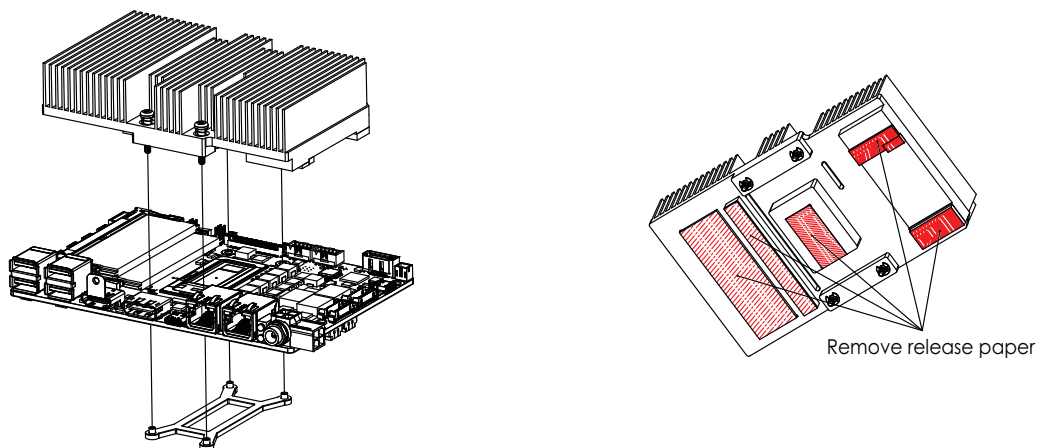


Figure 2.8 MIO-5377 Heatsink Installation

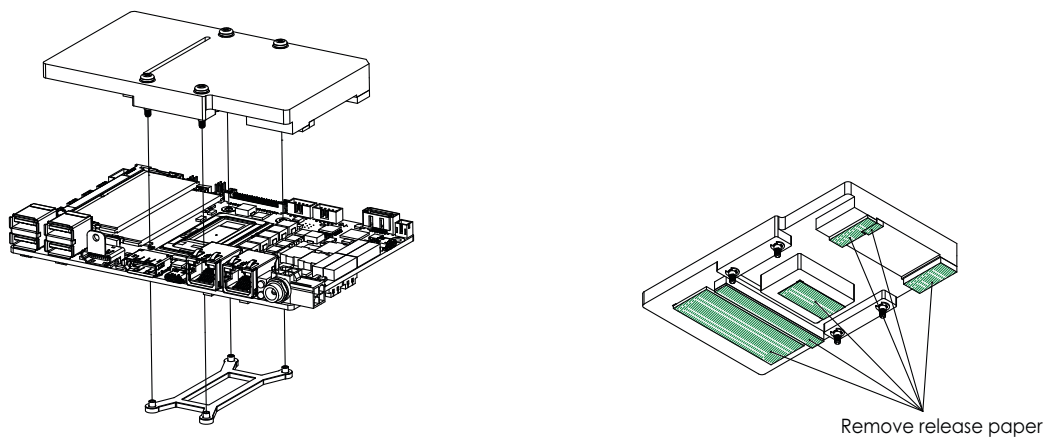


Figure 2.9 MIO-5377 Heatspreader Installation

Chapter 3

Jumpers and
Connectors

3.1 Jumpers

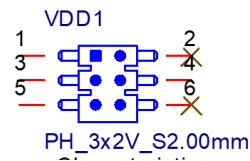


Table 3.1: Panel Voltage Selection Jumper: VDD1

Jumper Short	Panel Voltage
1-3	+3.3V (Default)
3-5	+5V
3-4	+12V

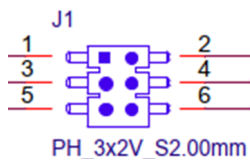


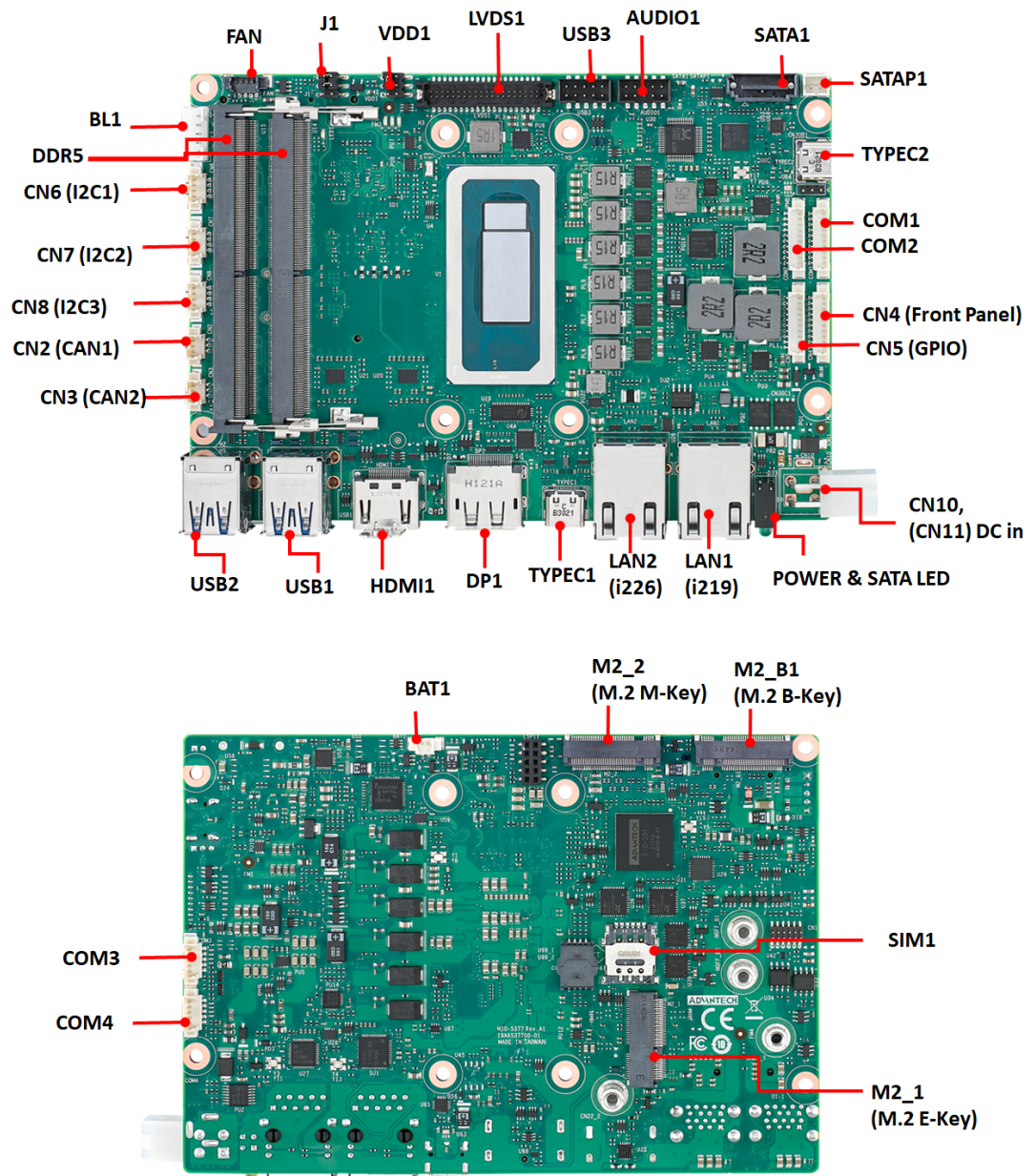
Table 3.2: AT Mode /Load BIOS Default: J1

Jumper Short	Panel Function
1-2	AT/ ATX MODE Selection 1-2 open: ATX mode 1-2 short: AT mode*
3-4	NORMAL_BIOS (Default) 3-4 open: Reserve 3-4 short: Reserve*
5-6	LOAD_BIOS_Default: 5-6 open: Normal* 5-6 short: Load BIOS Default

3.2 Connectors

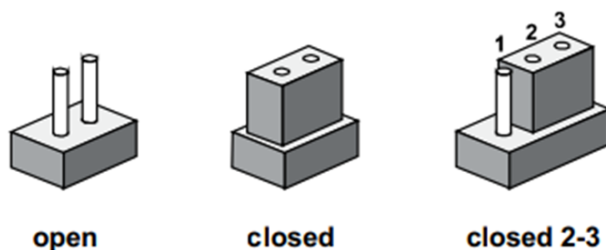
1	CN10	DC Power Input Connector (90D)
2	*CN10_1	DC Power Input Connector (180D)
3	*CN11	DC Jack
4	D33	Power & SATA LED
5	LAN1	I219 RJ-45 LAN Ports
6	LAN2	I226 RJ-45 LAN Ports
7	TYPEC1	Type-C Port (USB 3.2 / DP)
8	DP1	DisplayPort Connector
9	HDMI1	HDMI Connector
10	USB1	USB 3.2 Connector
11	USB2	USB 3.2 Connector
12	CN3	CAN Bus Port 1
13	CN2	CAN Bus Port 0
14	CN8	SOC_I2C Port1
15	CN7	SOC_I2C Port0
16	CN6	EC_I2C Port
17	BL1	Panel Inverter Connector
18	FAN	Smart FAN
19	J1	AT mode /Load BIOS default
20	VDD1	Panel Voltage Selection Jumper
21	LVDS1	LVDS Connector
22	USB3	USB 2.0 Internal Connector
23	AUDIO1	Audio Internal Connector
24	SATA1	SATA Connector
25	SATAP1	SATA Power Connector
26	TYPEC2	Type-C Port (TBT4)
27	COM1	COM Port Internal Connector 1
28	CN4	Front Panel Internal Connector
29	COM2	COM Port Internal Connector 2
30	CN5	GPIO Internal Connector
31	U14	DDR5 SO-DIMM 5.2 mm
32	U15	DDR5 SO-DIMM 9.2 mm
33	M2_1	M.2 E-Key Connector
34	COM4	COM Port Internal Connector 4
35	COM3	COM Port Internal Connector 3
36	BAT1	RTC battery Connector
37	M2_2	M.2 M-Key Connector
38	M2_B1	M.2 B-Key Connector
39	SIM1	NANO SIM SLOT

3.3 Locating Connectors



3.4 Setting Jumpers

You may configure your card to match the needs of your application by setting jumpers. A jumper is a metal bridge used to close an electric circuit. It consists of two metal pins and a small metal clip (often protected by a plastic cover) that slides over the pins to connect them. To “close” a jumper, you connect the pins with the clip. To “open” a jumper, you remove the clip. Sometimes a jumper will have three pins, labeled 1, 2, and 3. In this case you would connect either pins 1 and 2, or 2 and 3. The jumper settings are schematically depicted in this manual as follows:



A pair of needle-nose pliers may be helpful when working with jumpers. If you have any doubts about the best hardware configuration for your application, contact your local distributor or sales representative before you make any changes. Generally, you simply need a standard cable to make most connections.

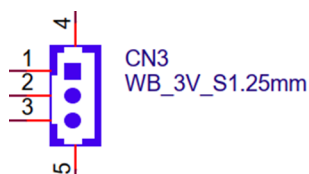


Table 3.3: CAN Bus Internal Connector: CN3

P/N	1654903500
Vendor / MPN	Aces / 85205-03001
Pin	Signal Pin Definition
1	CAN1_D+
2	CAN1_D-
3	GND



Table 3.4: CAN Bus Internal Connector: CN2

P/N	1654903500
Vendor / MPN	Aces / 85205-03001
Pin	Signal Pin Definition
1	CAN0_D+
2	CAN0_D-
3	GND

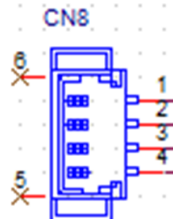


Table 3.5: I2C Internal Connector: CN8

P/N	1655904020
Vendor / MPN	Aces / 85205-04001
Pin	Signal Pin Definition
1	GND
2	SOC_I2C1_z_DAT
3	SOC_I2C1_z_CLK
4	+V33_I2CCONN1

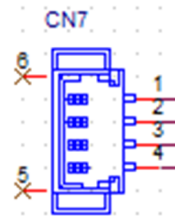


Table 3.6: I2C Internal Connector: CN7

P/N	1655904020
Vendor / MPN	Aces / 85205-04001
Pin	Signal Pin Definition
1	GND
2	SOC_I2C0_z_DAT
3	SOC_I2C0_z_CLK
4	+V33_I2CCONN0

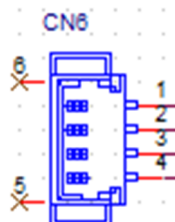


Table 3.7: I2C Internal Connector: CN6

P/N	1655904020
Vendor / MPN	Aces / 85205-04001
Pin	Signal Pin Definition
1	GND
2	EC_I2C0_z_DAT
3	EC_I2C0_z_CLK
4	+V33_I2CCONN

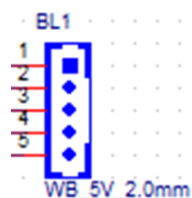


Table 3.8: Panel Inverter Connector: BL1

P/N	1653007388-01
Vendor / MPN	Pinrex / 721-81-05TWR0
Pin	Signal Pin Definition
1	+V12_1_INVERTER_0
2	GND
3	LVDS1_z_ENABKL
4	EC_LVDS1_z_PWM
5	+V5_1_INVERTER_0

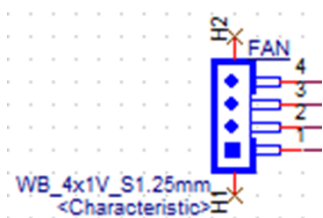


Table 3.9: Smart FAN Internal Connector: FAN

P/N	1653008788-01
Vendor / MPN	Aces / 50273-00401-001
Pin	Signal Pin Definition
1	GND
2	+V12
3	FAN_SPEED
4	FAN_V5_PWM

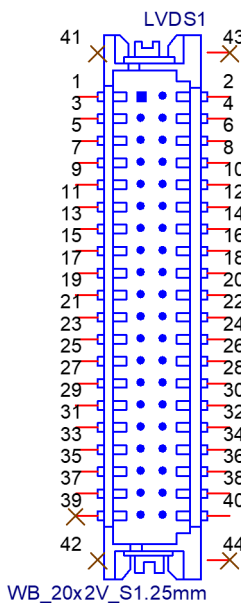
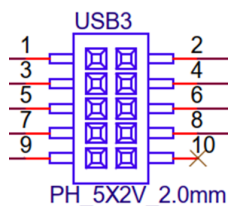


Table 3.10: LVDS Connector: LVDS1

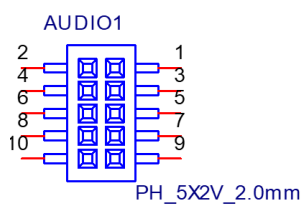
P/N	1653008443-01
Vendor / MPN	Hirose / DF13E-40DP-1.25V(52)
Pin	Signal Pin Definition
1	+V_LCD
2	+V_LCD
3	GND
4	GND
5	+V_LCD
6	+V_LCD
7	LVDS1_0_D0-
8	LVDS1_1_D0-
9	LVDS1_0_D0+
10	LVDS1_1_D0+
11	GND
12	GND
13	LVDS1_0_D1-
14	LVDS1_1_D1-
15	LVDS1_0_D1+
16	LVDS1_1_D1+
17	GND
18	GND
19	LVDS1_0_D2-
20	LVDS1_1_D2-
21	LVDS1_0_D2+
22	LVDS1_1_D2+
23	GND
24	GND
25	LVDS1_0_CLK-
26	LVDS1_1_CLK-
27	LVDS1_0_CLK+
28	LVDS1_1_CLK+
29	GND
30	GND
31	LVDS0_DDCCLK_AUX+
32	LVDS0_DDCCLK_AUX-
33	GND
34	GND
35	LVDS1_0_D3-
36	LVDS1_1_D3-
37	LVDS1_0_D3+
38	LVDS1_1_D3+
39	NC
40	LVDS1_VCON
41	NC
42	NC
43	NC

Table 3.10: LVDS Connector: LVDS1

44	NC
----	----

**Table 3.11: USB 2.0 Dual-Port Internal Connector: USB 3**

P/N	1653008214-01
Vendor / MPN	Pinrex / 52C-90-10GBE0
Pin	Signal Pin Definition
1	+V5SB_USB_UTC
2	+V5SB_USB_UTC
3	USB8_z_P-
4	USB9_z_P-
5	USB8_z_P+
6	USB9_z_P+
7	GND
8	GND
9	GND
10	NC

**Table 3.12: Audio Internal Connector: AUDIO1**

P/N	1653008214-01
Vendor / MPN	Pinrex / 52C-90-10GBE0
Pin	Signal Pin Definition
1	LOUTR
2	LINR
3	AUD_CONN_GND
4	AUD_CONN_GND
5	LOUTL
6	LINL
7	AUD_CONN_GND
8	FRONT_JD
9	MIC1R
10	MIC1L

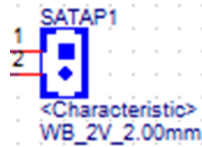


Table 3.13: SATA Power Connector: SATA_P1

P/N	1653007538-01
Vendor / MPN	Pinrex / 721-81-02TW00
Pin	Signal Pin Definition
1	+V5SATA0
2	GND

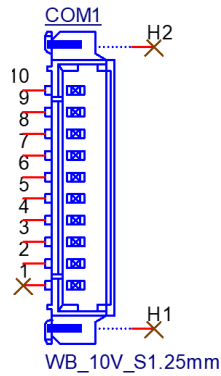


Table 3.14: COM-Port Internal Connector 1: COM1

P/N	1653007728-02
Vendor / MPN	Aces / 50273-0107N-002
Pin	Signal Pin Definition
1	NC
2	COM1_RI#
3	COM1_DTR#
4	COM1_CTS#
5	COM1_TXD
6	COM1_RTS#
7	COM1_RXD
8	COM1_DSR#
9	COM1_DCD#
10	GND

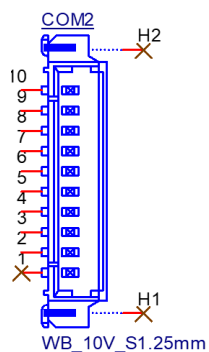


Table 3.15: COM-Port Internal Connector 2: COM2

P/N	1653007728-02
Vendor / MPN	Aces / 50273-0107N-002
Pin	Signal Pin Definition
1	NC
2	COM2_RI#
3	COM2_DTR#
4	COM2_CTS#
5	COM2_TXD
6	COM2_RTS#
7	COM2_RXD
8	COM2_DSR#
9	COM2_DCD#
10	GND

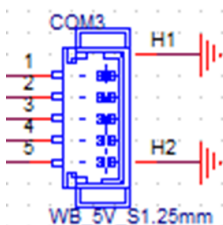


Table 3.16: COM-Port Internal Connector 3: COM3

P/N	1655004032
Vendor / MPN	Aces / 85205-05701
Pin	Signal Pin Definition
1	COM3_TXD
2	COM3_RTS#
3	COM3_RXD
4	COM3_CTS#
5	GND

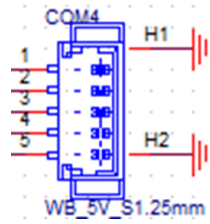


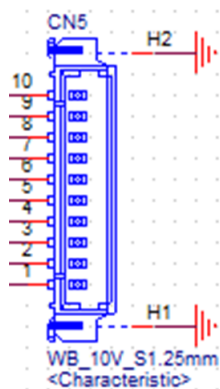
Table 3.17: COM Port Internal Connector 4: COM4

P/N	1655004032
Vendor / MPN	Aces / 85205-05701
Pin	Signal Pin Definition
1	COM4_TXD
2	COM4_RTS#
3	COM4_RXD
4	COM4_CTS#
5	GND

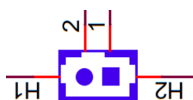


Table 3.18: Front Panel Internal Connector: CN4

P/N	1653007728-02
Vendor / MPN	Aces / 50273-0107N-002
Pin	Signal Pin Definition
1	GND
2	BUZZER-
3	BUZZER+
4	RDC_CASEOPEN
5	SATA_HDD_LED#
6	FP_a_PSIN#
7	FP_a_RST#
8	+V3.3
9	NC
10	+V5


Table 3.19: GPIO Internal Connector: CN5

P/N	1653007728-02
Vendor / MPN	Aces / 50273-0107N-002
Pin	Signal Pin Definition
1	GND
2	EC_P1_GPIO7
3	EC_P1_GPIO2
4	EC_P1_GPIO6
5	EC_P1_GPIO1
6	EC_P1_GPIO5
7	EC_P1_GPIO0
8	EC_P1_GPIO4
9	+V5_P1_GPIO
10	EC_P1_GPIO3


Table 3.20: RTC battery Connector: BAT1

Pin	Signal Pin Definition
1	GND
2	+VBAT_a1

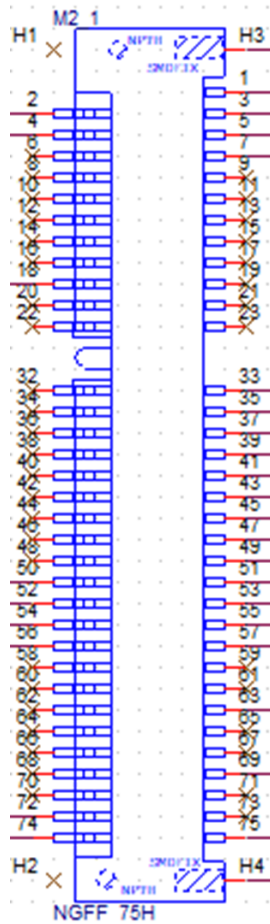


Table 3.21: M.2 E-Key Connector: M2_1

Pin	Signal Pin Definition
1	GND
2	+V3.3SB_M.2_E
3	USB6_z_P+
4	+V3.3SB_M.2_E
5	USB6_z_P-
6	NC
7	GND
8	NC
9	NC
10	NC
11	NC
12	NC
13	NC
14	NC
15	NC
16	NC
17	NC
18	GND
19	NC
20	NC
21	NC
22	NC

Table 3.21: M.2 E-Key Connector: M2_1

23	NC
32	NC
33	GND
34	NC
35	PCIE_M2_z_TX7+
36	NC
37	PCIE_M2_z_TX7-
38	NC
39	GND
40	NC
41	PCIE_M2_RX11+
42	NC
43	PCIE_M2_RX11-
44	NC
45	GND
46	NC
47	CLK_M2E_z_PCIE+
48	NC
49	CLK_M2E_z_PCIE-
50	SUSCLK_z_EKEY
51	GND
52	PLTRST_BUFFER#
53	PCIE_a_CLKREQ2#
54	BT_DISABLE#
55	PCIE_WAKE#
56	WIFI_DISABLE#
57	GND
58	NC
59	NC
60	NC
61	NC
62	NC
63	GND
64	NC
65	NC
66	NC
67	NC
68	NC
69	GND
70	NC
71	NC
72	+V3.3SB_M.2_E
73	NC
74	+V3.3SB_M.2_E
75	GND
H1	NC
H2	NC

Table 3.21: M.2 E-Key Connector: M2_1

H3	GND
H4	GND

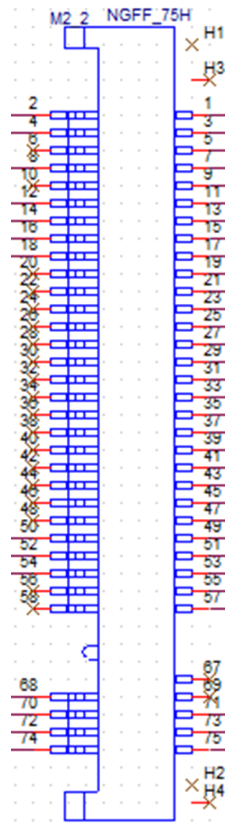


Table 3.22: M.2 M-Key Connector: M2_2

Pin	Signal Pin Definition
1	GND
2	+V3.3_M.2
3	GND
4	+V3.3_M.2
5	PCIE4_KEY-M_RX3-
6	NC
7	PCIE4_KEY-M_RX3+
8	M.2_PLN#
9	GND
10	NC
11	PCIE4_KEY-M_a_TX3-
12	+V3.3_M.2
13	PCIE4_KEY-M_a_TX3+
14	+V3.3_M.2
15	GND
16	+V3.3_M.2
17	PCIE4_KEY-M_RX2-
18	+V3.3_M.2
19	PCIE4_KEY-M_RX2+
20	NC
21	GND

Table 3.22: M.2 M-Key Connector: M2_2	
22	NC
23	PCIE4_KEY-M_a_TX2-
24	NC
25	PCIE4_KEY-M_a_TX2+
26	NC
27	GND
28	NC
29	PCIE4_KEY-M_RX1-
30	NC
31	PCIE4_KEY-M_RX1+
32	NC
33	GND
34	NC
35	PCIE4_KEY-M_a_TX1-
36	NC
37	PCIE4_KEY-M_a_TX1+
38	NC
39	GND
40	NC
41	PCIE4_KEY-M_RX0-
42	NC
43	PCIE4_KEY-M_RX0+
44	NC
45	GND
46	NC
47	PCIE4_KEY-M_a_TX0-
48	NC
49	PCIE4_KEY-M_a_TX0+
50	PLTRST_MKEY_BUFFER#
51	GND
52	CLK2_M2MB_a_PCIE_REQ#
53	CK_100M_a_MKEY_N
54	M.2_PCIE_WAKE#
55	CK_100M_a_MKEY_P
56	NC
57	GND
58	NC
67	NC
68	PCH_SUSCLK_R_MKEY
69	NC
70	+V3.3_M.2
71	GND
72	+V3.3_M.2
73	GND
74	+V3.3_M.2
75	GND
H1	NC

Table 3.22: M.2 M-Key Connector: M2_2

H2	NC
H3	NC
H4	NC



Table 3.23: M.2 B-Key Connector: M2_B1

Pin	Signal Pin Definition
1	M2B1_CFG3
2	+V3.3A_M.2_B
3	GND
4	+V3.3A_M.2_B
5	GND
6	M2B1_FULL_CARD_OFF#
7	USB_M2B1_P
8	M2B1_W_DISABLE1#
9	USB_M2B1_N
10	M2B1_LED1#
11	GND
20	M2B1_PCIE_DIS
21	M2B1_CFG0
22	M2B1_ANT_CFG
23	M2B1_WAKE_ON_WWAN#
24	M2B1_ANT_TUNER
25	M2B1_DPR
26	M2B1_W_DISABLE2#

Table 3.23: M.2 B-Key Connector: M2_B1

27	GND
28	NC
29	NC
30	M2B1_UIM_RESET
31	NC
32	M2B1_UIM_CLK
33	GND
34	M2B1_UIM_DATA
35	NC
36	M2B1_UIM_PWR
37	NC
38	NC
39	GND
40	NC
41	M2B1_PCIE_RX-
42	NC
43	M2B1_PCIE_RX+
44	NC
45	GND
46	NC
47	M2B1_PCIE_TX-
48	NC
49	M2B1_PCIE_TX+
50	M2B1_PERST#
51	GND
52	M2B1_a_CLKREQ#
53	CLK100M_a_M2B1-
54	M2B1_PCIEWAKE#
55	CLK100M_a_M2B1+
56	NC
57	GND
58	NC
59	NC
60	NC
61	NC
62	NC
63	NC
64	NC
65	NC
66	NC
67	M2B1_a_RESET#
68	M2B1_SUSCLK
69	M2_SATA1B_PEDET
70	+V3.3A_M.2_B
71	GND
72	+V3.3A_M.2_B
73	GND

Table 3.23: M.2 B-Key Connector: M2_B1

74	+V3.3A_M.2_B
75	M2B1_CFG2
H1	NC
H2	NC
H3	GND
H4	GND

Chapter 4

AMI BIOS Setup

AMIBIOS has been integrated into motherboards for decades. With the AMIBIOS setup program, you can modify BIOS settings and control the various system features. This chapter describes basic navigation of the MIO-5377 BIOS setup screens.



AMI BIOS ROM has a built-in setup program that allows users to modify the basic system configuration. This information is stored in battery-backed CMOS so it retains the setup information when the power is turned off.

4.1 Entering Setup

Turn on the computer and check for the patch code. If there is a number assigned to the patch code, it means that the BIOS supports your CPU. If there is no number assigned to the patch code, please contact an Advantech application engineer to obtain an up-to-date patch code file. This will ensure that your CPU's system status is valid. After ensuring that you have a number assigned to the patch code, press and you will immediately be allowed to enter the setup.

4.1.1 Main Setup

When you first enter the BIOS Setup Utility, you will encounter the Main setup screen. You can always return to the Main setup screen by selecting the Main tab. There are two Main Setup options. They are described in this section. The Main BIOS Setup screen is shown below.



The Main BIOS setup screen has two main frames. The left frame displays all the options that can be configured. Grayed-out options cannot be configured; options in blue can. The right frame displays the key legend.

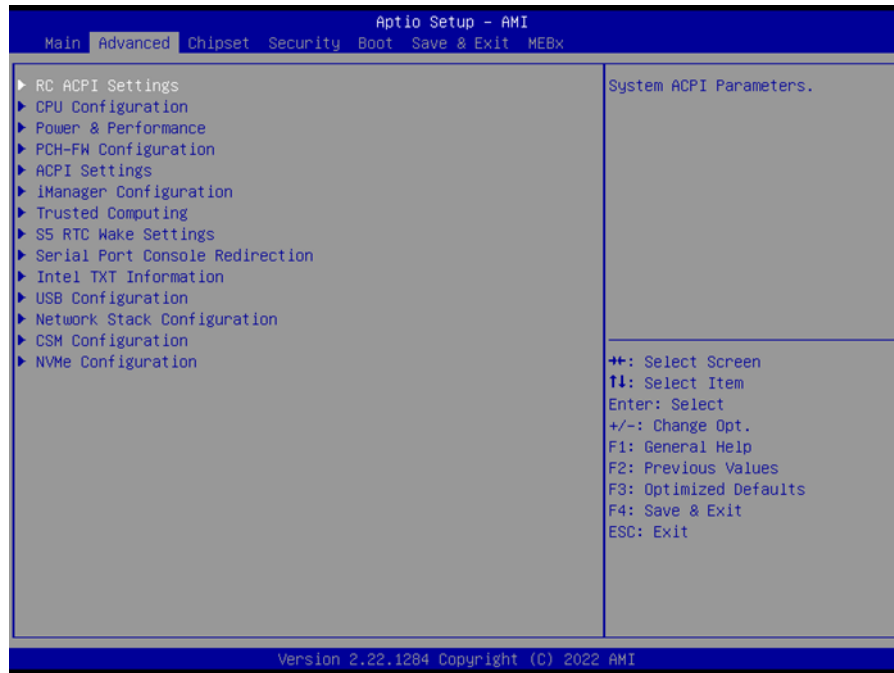
Above the key legend is an area reserved for a text message. When an option is selected in the left frame, it is highlighted in white. Often a text message will accompany it.

■ System Time / System Date

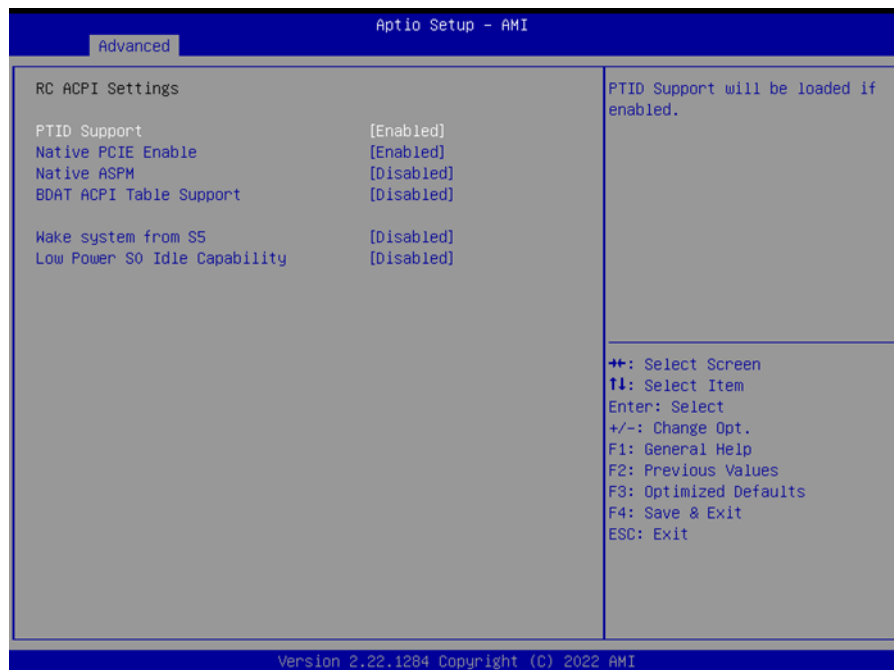
Use this option to change the system time and date. Highlight System Time or System Date using the <Arrow> keys. Enter new values through the keyboard. Press the <Tab> key or the <Arrow> keys to move between fields. The date must be entered in MM/DD/YY format. The time must be entered in HH:MM:SS format.

4.1.2 Advanced BIOS Features Setup

Select the Advanced tab from the MIO-5377 setup screen to enter the Advanced BIOS Setup screen. You can select any of the items in the left frame of the screen, such as CPU Configuration, to go to the sub-menu for that item. You can display an Advanced BIOS Setup option by highlighting it using the <Arrow> keys. All Advanced BIOS Setup options are described in this section. The Advanced BIOS Setup screens are shown below. The sub-menus are described on the following pages.



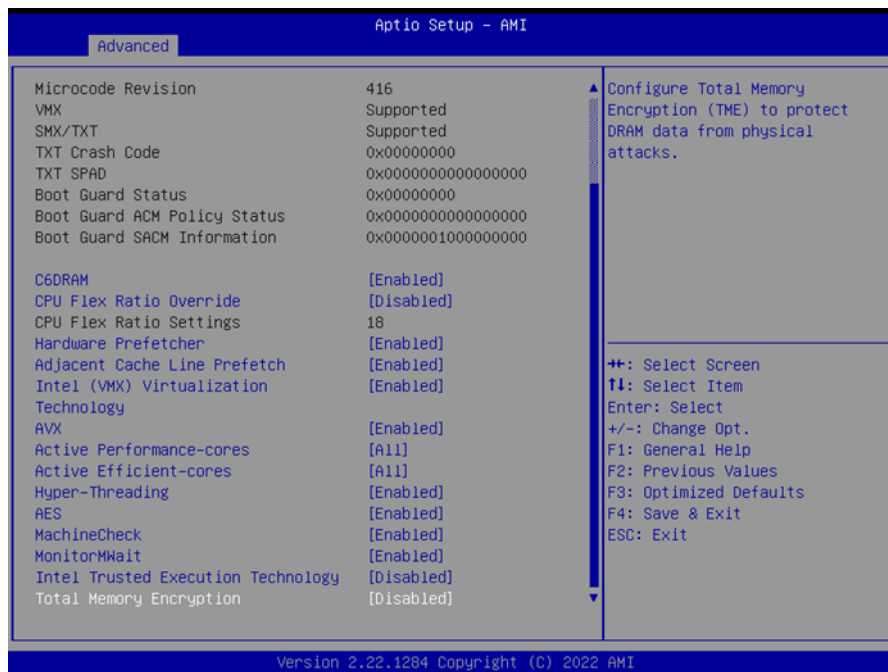
4.1.2.1 RC ACPI Settings



- **PTID Support**
Determines if it is Enabled to load the PTID Table.
- **Native PCIE Enable**
Enable/Disable PCIE Native Control reported in the ACPI Table.
- **Native ASPM**
Choose if the ASPM feature is to be controlled by the OS or BIOS.
- **BDAT ACPI Table Support**
Determines if it is Enabled to support the BDAT ACPI Table.
- **Low Power S0 Idle Capability**

This item Enables/Disables ACPI Low Power S0 Idle Capability under the OS.

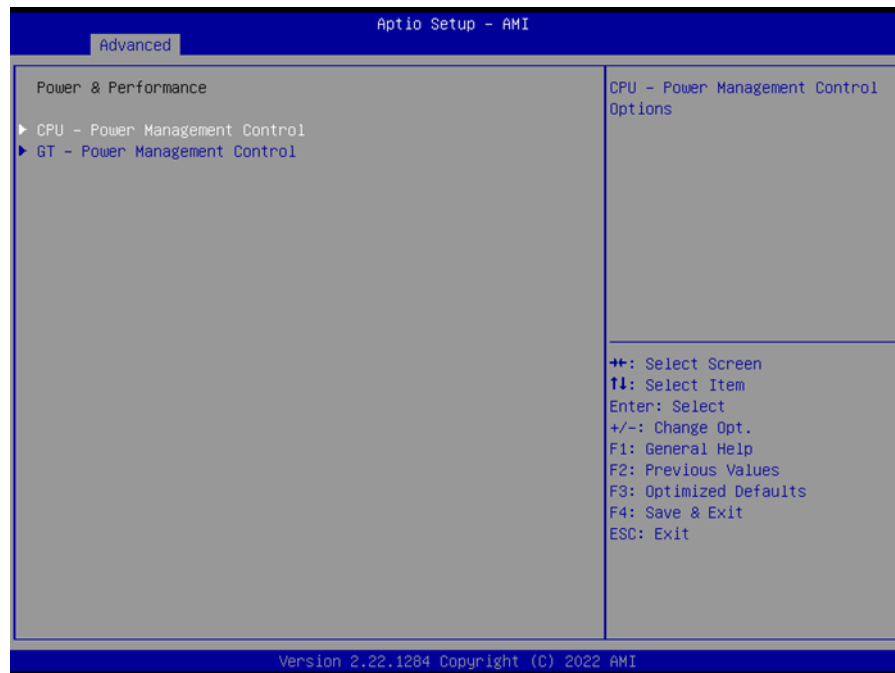
4.1.2.2 CPU Configuration



- **C6DRAM**
Enable/Disable moving DRAM contents to PRM memory when the CPU is in C6 state.
- **CPU Flex Ratio Override**
Enable/Disable CPU Flex Ratio Programming.
- **Hardware Prefetcher**
This item allows users to Enable or Disable the hardware prefetcher feature.
- **Adjacent Cache Line Prefetch**
This item allows users to Enable or Disable the adjacent cache line prefetch feature.
- **Intel (VMX) Virtualization Technology**
When Enabled, a VMM can utilize the additional hardware capability provided by Vanderpool Technology.
- **AVX**
Enable/Disable the AVX 2/3 instructions.
- **Active Performance-cores**
Number of P-cores to enable in each processor package.
- **Active Efficient-cores**
Number of E-cores to enable in each processor package.
- **Hyper-Threading**
This item allows users to Enable/Disable Hyper-Threading Technology.
- **AES**
Enable/Disable AES (Advanced Encryption Standard).
- **MachineCheck**
Enable/Disable Machine Check.
- **MonitorMWait**
Enable/Disable MonitorMWait.

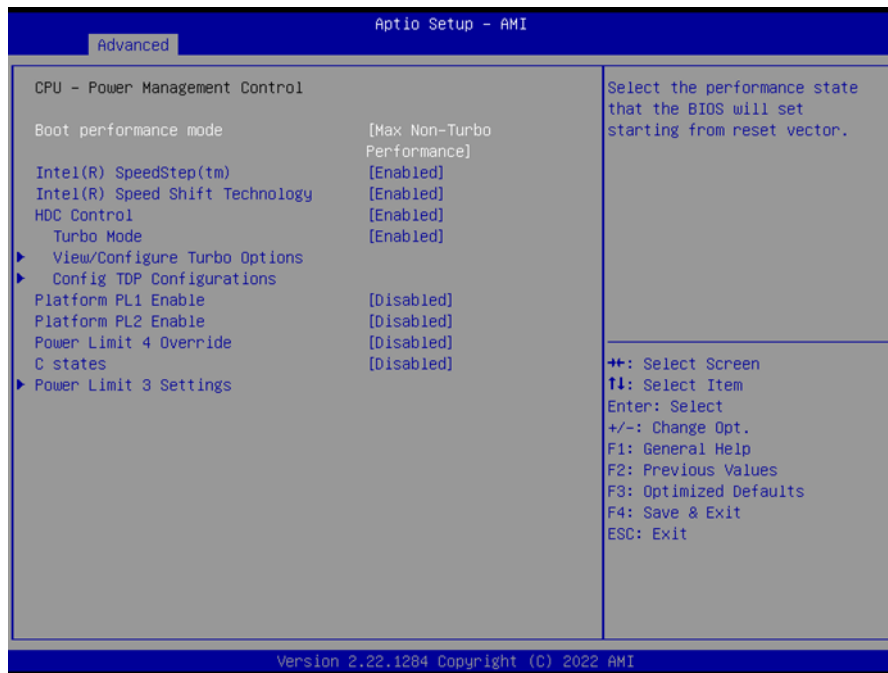
- **Intel Trusted Execution Technology**
Enables utilization of additional hardware capability provided by Intel® Trusted Execution Technology.
- **Total Memory Encryption**
Configure Total Memory Encryption (TME) to protect DRAM data from physical attacks.

4.1.2.3 Power & Performance



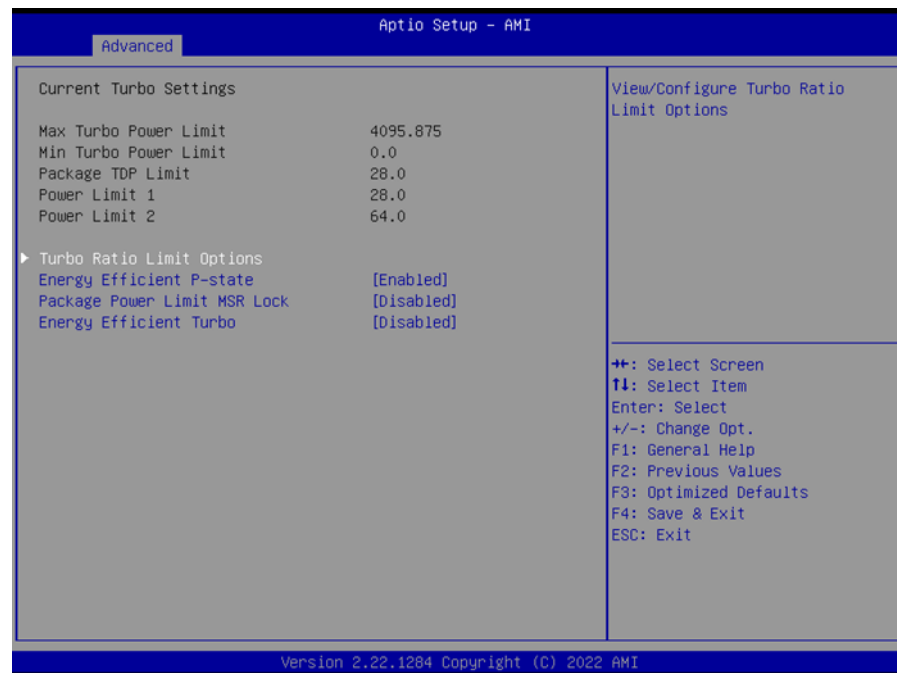
- **CPU – Power Management Control**
CPU – Power Management Control Options
- **GT – Power Management Control**
GT – Power Management Control Options

4.1.2.3.1 CPU - Power Management Control



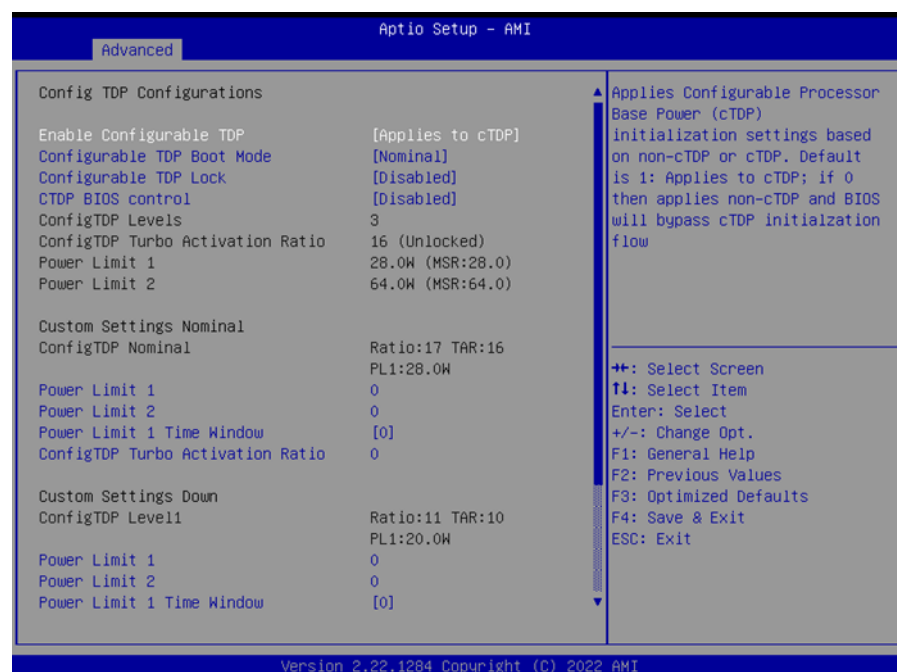
- **Boot performance mode**
Select the performance state that the BIOS will set before OS handoff.
- **Intel® SpeedStep™**
Allows more than two frequency ranges to be supported.
- **Intel® Speed Shift Technology**
Enable/Disable Intel® Speed Shift Technology support.
- **HDC Control**
Enable/Disable Intel HDC.
- **Turbo Mode**
Enable/Disable processor turbo mode.
- **View/Configure Turbo Options**
View and Configure Turbo Options.
- **Config TDP Configurations**
Config TDP Configurations.
- **Platform PL1 Enable**
Enable/Disable Platform Power Limit 1 programming.
- **Platform PL2 Enable**
Enable/Disable Platform Power Limit 1 programming.
- **Power Limit 4 Override**
Enable/Disable Power Limit 4 override.
- **C states**
Enable/Disable CPU Power Management.
- **Power Limit 3 Settings**
Power Limit 3 Settings.

View/Configure Turbo Options



- **Turbo Ratio Limit Option**
View/Configure Turbo Ratio Limit Options.
- **Energy Efficient P-state**
Enable/Disable Energy Efficient P-state feature.
- **Package Power Limit MSR Lock**
Enable/Disable locking of Package Power Limit settings.
- **Energy Efficient Turbo**
Enable/Disable the Energy Efficient Turbo feature.

Config TDP Configurations



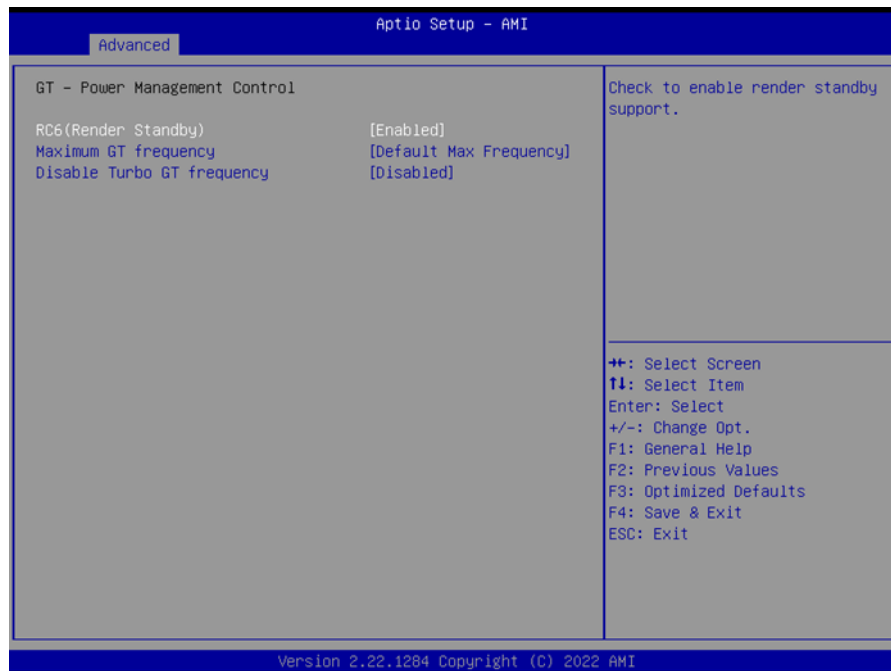
- **Enable Configurable TDP**
Applies TDP initialization settings based on non-cTDP or cTDP.
- **Configurable TDP Boot Mode**
Configurable TDP Mode as Nominal/Up/Down/Deactivate TDP selection.
- **Configurable TDP Lock**
Configurable TDP Mode Lock sets the Lock bit.
- **CTDP BIOS control**
Enables CTDP control via runtime ACPI BIOS method.

Power Limit 3 Settings



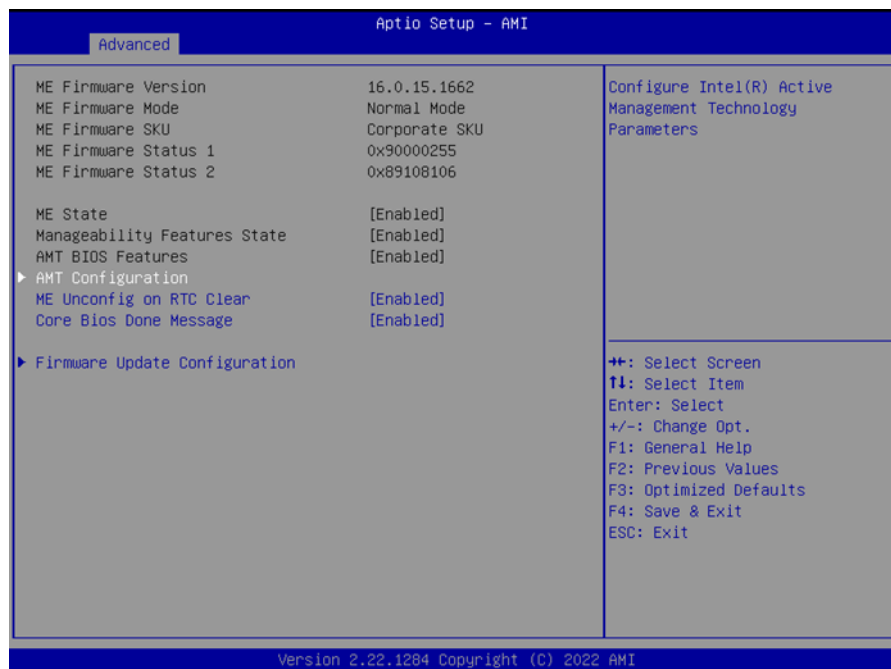
- **Power Limit 3 Override**
Enable/Disable Power Limit 3 override.

4.1.2.3.2GT - Power Management Control



- **RC6(Render Standby)**
Check to Enable render standby support.
- **Maximum GT frequency**
Maximum GT frequency limited by user.
- **Disable Turbo GT frequency**
Enable/Disable Turbo GT frequency.

4.1.2.4 PCH-FW Configuration



- **ME State**
When Disabled ME will put ME into Temporarily Disabled Mode.

- **Manageability Feature State**
When Disabled, ME will not be unconfigured on RTC Clear.
- **AMT BIOS Features**
When Disabled, ME will not be unconfigured on RTC Clear.
- **AMT Configuration**
Configure Intel® Active Management Technology Parameters.
- **ME Unconfig on RTC Clear**
When Disabled, ME will not be unconfigured on RTC Clear.
- **Core BIOS Done Message**
Enable/Disable Core BIOS Done message sent to ME.
- **Firmware Update Configuration**
Configure Management Engine Technology Parameters.

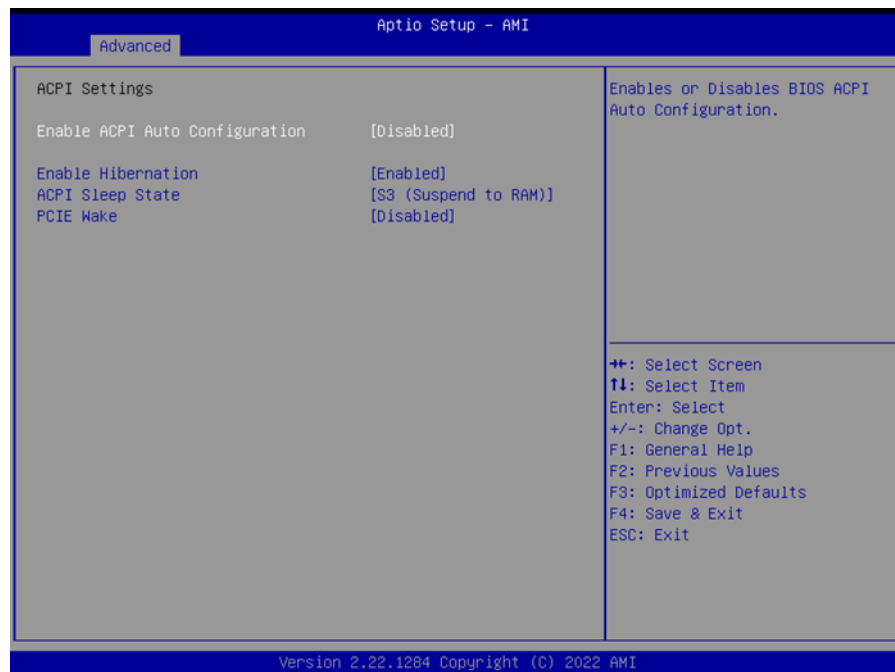
4.1.2.4.1 AMT Configuration



- **USB Provision of AMT**
Enable/Disable AMT BIOS Provisioning.
- **MAC Pass Through**
Enable/Disable the MAC Pass Through function.
- **Active Remote Assistance Process**
Trigger CIRA boot.
- **Unconfigure ME**
Unconfigure ME by resetting the MEBx password to default on the next boot.
- **ASF Configuration**
Configure Alert Standard Format parameters.
- **Secure Erase Configuration**
Secure Erase configuration menu.
- **One Click Recovery(OCR) Configuration**
Configuration setting for One Click Recovery.
- **Remote Platform Erase Configuration**

Remote Platform Erase configuration menu.

4.1.2.5 ACPI Settings



- **Enable ACPI Auto Configuration**
Enable or disable BIOS ACPI auto configuration.
- **Enable Hibernation**
Enables or Disables the system's ability to Hibernate (OS/S4 Sleep State). This option may be not effective with some OS.
- **ACPI Sleep State**
Select the highest ACPI sleep state the system will enter when the SUSPEND button is pressed.
- **PCIe Wake**
Enable or Disable PCIe to wake the system from S5.

4.1.2.6 iManager Configuration



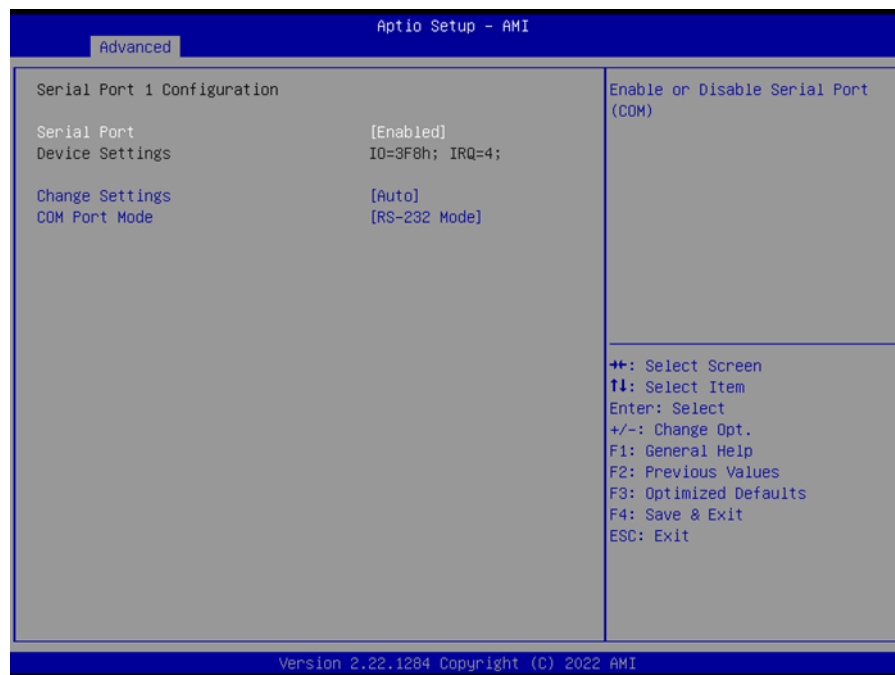
- **CPU Shutdown Temperature**
Enable/Disable CPU Shutdown Temperature.
- **Power Saving Mode**
Enable/Disable power saving mode.
- **Backlight Enable Polarity**
Switch Backlight Enable Polarity for Native or Invert.
- **Backlight Control Mode**
Switch Backlight Control to PWM or DC mode.
- **Brightness PWM Polarity**
Backlight Control Brightness PWM Polarity for Native or Invert.
- **Brightness Control Enable**
Choose to control the LVDS brightness value by EC or User override during the POST stage.
- **Serial Port 1 Configuration**
Set Parameters of Serial Port 1.
- **Serial Port 2 Configuration**
Set Parameters of Serial Port 2.
- **Serial Port 3 Configuration**
Set Parameters of Serial Port 3.
- **Serial Port 4 Configuration**
Set Parameters of Serial Port 4.
- **Hardware Monitor**
Monitor hardware Status.
- **Watch Dog Timer Configuration**
Watch Dog Timer Configuration Page.
- **Case Open Detection**
Enable or Disable Case Open Detect Function.
- **GPIO Configuration**

GPIO Configuration Settings.

- **ACPI Report Method Configuration**

Select ACPI Reporting Method for EC Devices.

4.1.2.6.1 Serial Port 1 Configuration



- **Serial Port**

Enable or Disable Serial Port (COM).

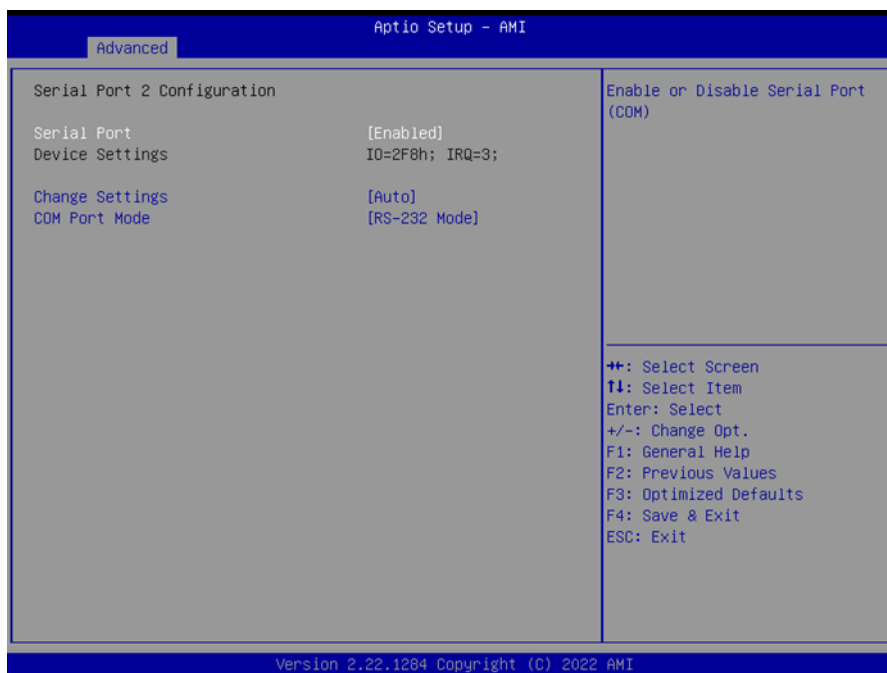
- **Change Settings**

Select an optimal setting for Super IO device.

- **COM Port Mode**

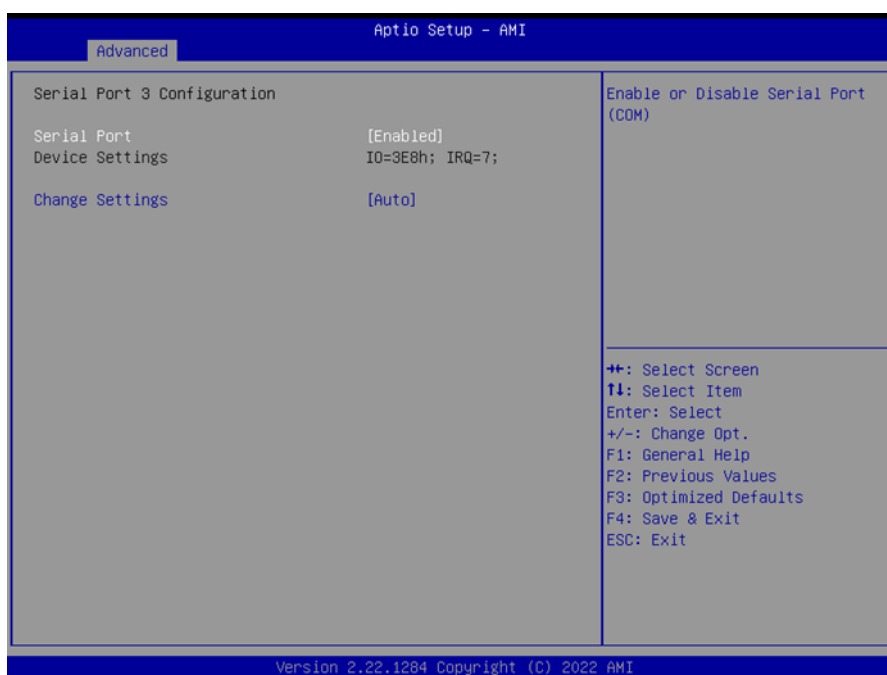
COM Port Mode Select.

4.1.2.6.2 Serial Port 2 Configuration



- **Serial Port**
Enable or Disable Serial Port (COM).
- **Change Settings**
Select an optimal setting for Super IO device.
- **COM Port Mode**
COM Port Mode Select.

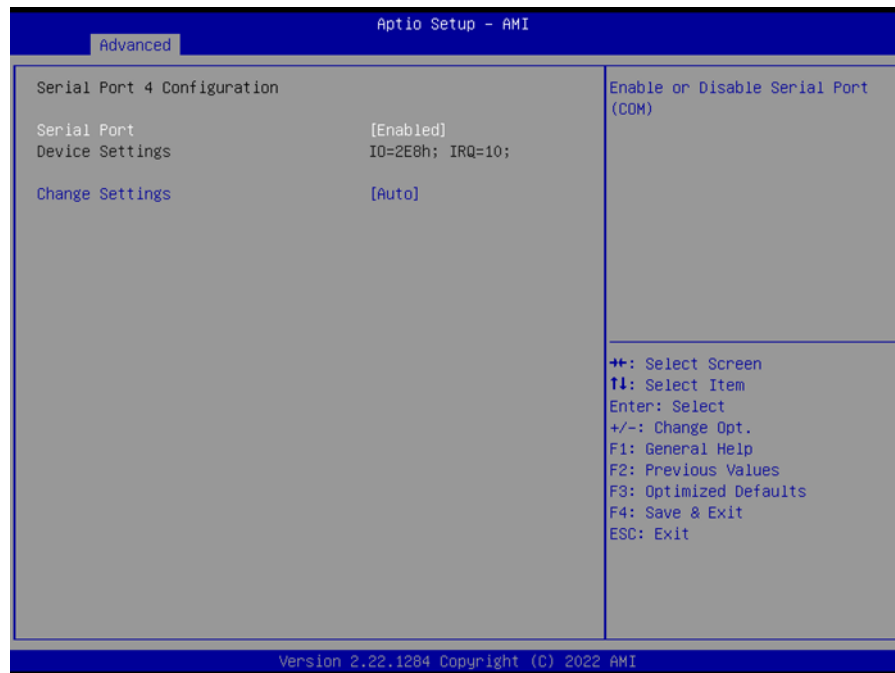
4.1.2.6.3 Serial Port 3 Configuration



- **Serial Port**
Enable or Disable Serial Port (COM).
- **Change Settings**

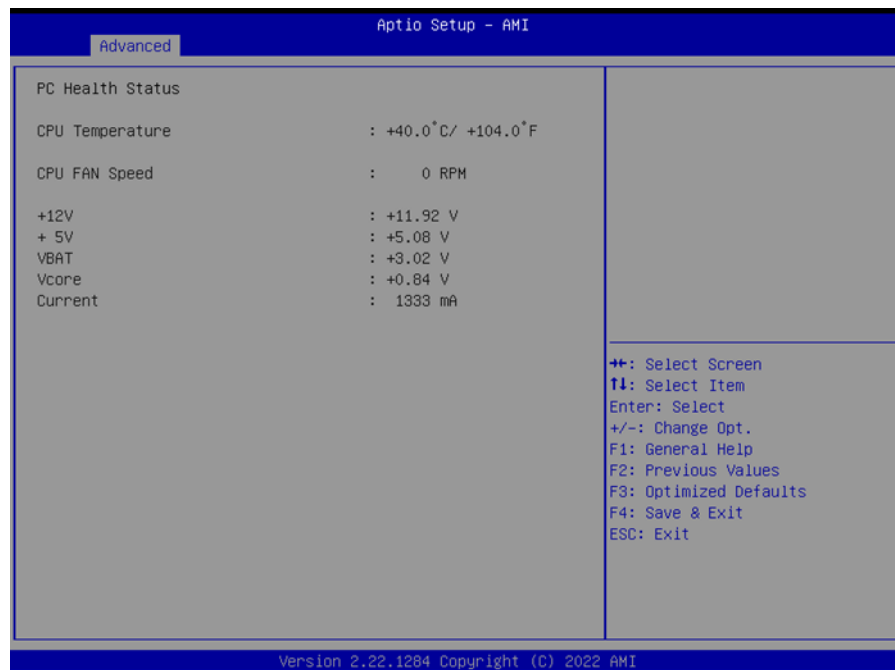
Select an optimal settings for Super IO device.

4.1.2.6.4 Serial Port 4 Configuration



- **Serial Port**
Enable or Disable Serial Port (COM).
- **Change Settings**
Select an optimal setting for Super IO device.

4.1.2.6.5 Hardware Monitor



4.1.2.6.6 Watch Dog Timer Configuration



- **Watch Dog Timer**
Enable or Disable the Watch Dog Timer Function.

4.1.2.6.7 GPIO Configuration



- **GPIO Control Enable**
Choose to control GPIO by EC or user override during the POST stage.
- **GPIO0/1/2/3/4/5/6/7**
Configure GPIO0/1/2/3/4/5/6/7.

4.1.2.6.8 ACPI Report Method Configuration



- **ACPI Report Method Control**
Select ACPI Reporting Method for EC Devices.
- **Active High-Speed COM Port**
Select to Enable High-Speed COM Port or Standard COM Port.
- **ACPI Report Method for I2C Bus**
Select ACPI Reporting Method for EC I2C Bus.
- **ACPI Report Method for CAN Bus**
Select ACPI Reporting Method for EC CAN Bus.
- **ACPI Report Method for GPIO**
Select ACPI Reporting Method for EC GPIO.

4.1.2.7 Trusted Computing



- **Security Device Support**
Enable or disable BIOS support for security device.
- **SHA256 PCR Bank**
Enable or Disable SHA256 PCR Bank.
- **Pending operation**
Schedule an operation for the Security Device.
- **Platform Hierarchy**
Enable or Disable Platform Hierarchy.
- **Storage Hierarchy**
Enable or Disable Storage Hierarchy.
- **Endorsement Hierarchy**
Enable or Disable Endorsement Hierarchy.
- **Physical Presence Spec Version**
Select to tell the OS to support PPI Spec Version 1.2 or 1.3.
- **Device Select**
TPM 1.2 will restrict support to TPM 1.2 devices, TPM 2.0 will restrict support to TPM 2.0 devices.

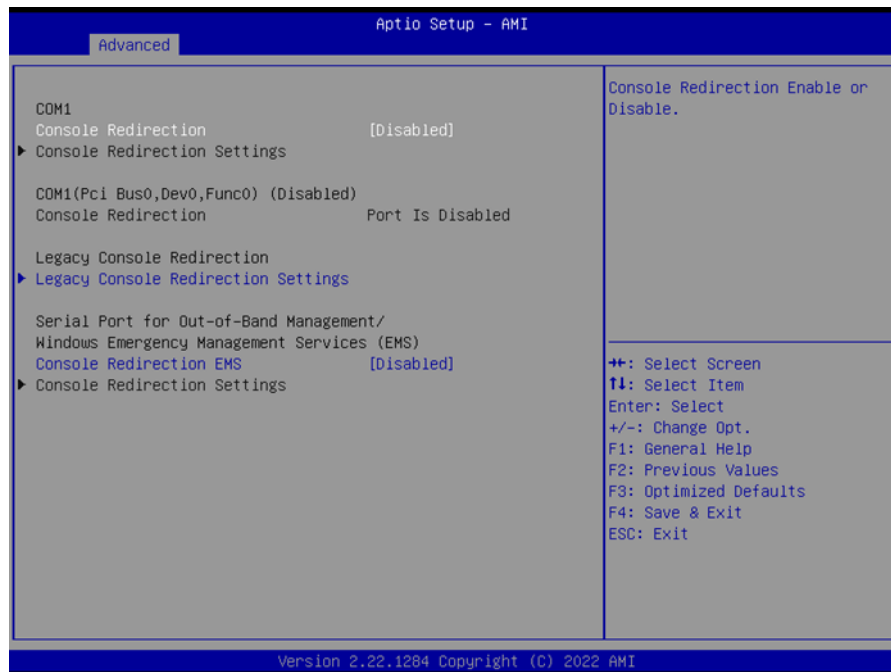
4.1.2.8 S5 RTC Wake Settings



- **Wake system from S5**

Enable or disable System wake on an alarm event. Select FixedTime for the system to wake on the hr:min:sec specified.

4.1.2.9 Serial Port Console Redirection



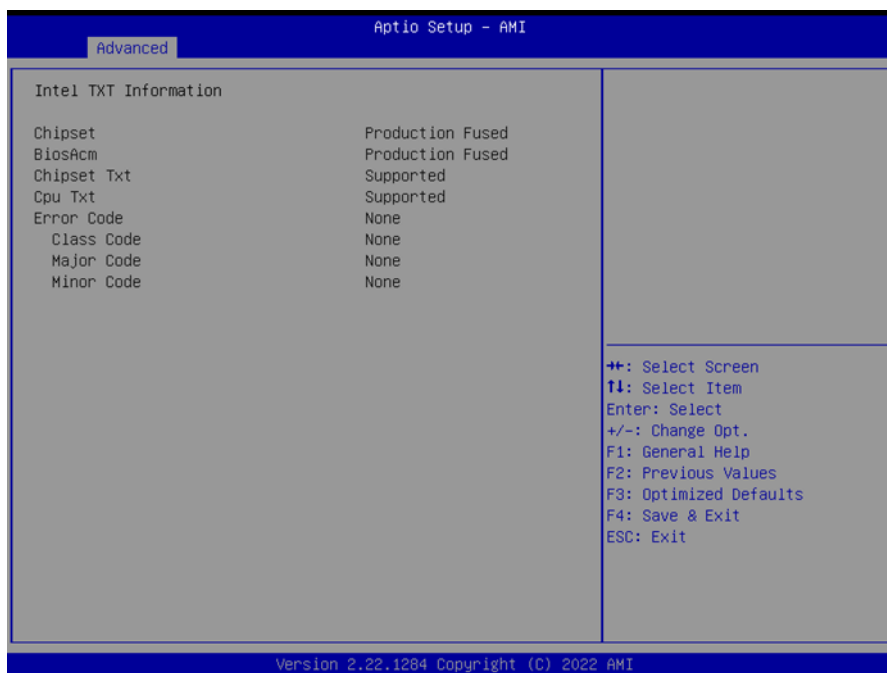
- **Console Redirection**

This item allows users to configure console redirection detailed settings.

- **Console Redirection EMS**

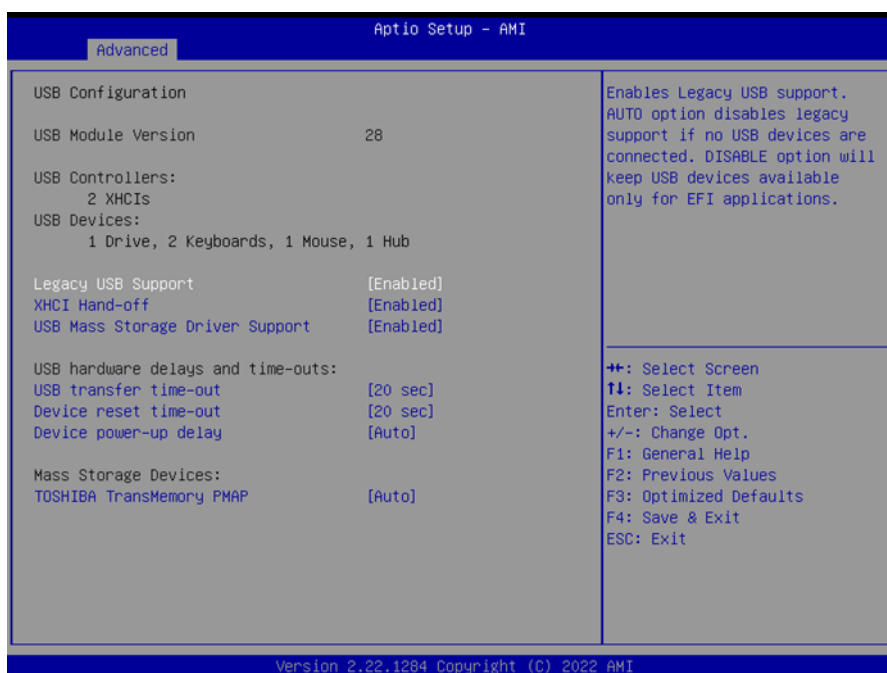
This item allows users to Enable or Disable console redirection for Microsoft Windows Emergency Management Services (EMS).

4.1.2.10 Intel TXT Information



- **Intel TXT Information**
Display Intel TXT information.

4.1.2.11 USB Configuration



- **Legacy USB Support**
Enables Legacy USB support. The Auto option disables legacy support if no USB devices are connected. The Disabled option will keep USB devices available only for EFI applications.
- **XHCI Hand-off**
This is a workaround for OS without XHCI hand-off support. The XHCI ownership change should be claimed by the XHCI driver.

- **USB Mass Storage Driver Support**
Enable/Disable USB Mass Storage Driver Support.
- **USB transfer time-out**
Time-out value for control, bulk, and interrupt transfers.
- **Device reset time-out**
A USB mass storage device starts unit command time-out.
- **Device power-up delay**
Maximum time the device will take before it properly reports itself to the Host Controller. 'Auto' uses the default value: for a Root port it is 100 ms, for a Hub port the delay is taken from the Hub descriptor.

4.1.2.12 Network Stack Configuration



- **Network Stack**
Enable/Disable UEFI Network Stack.

4.1.2.13 CSM Configuration



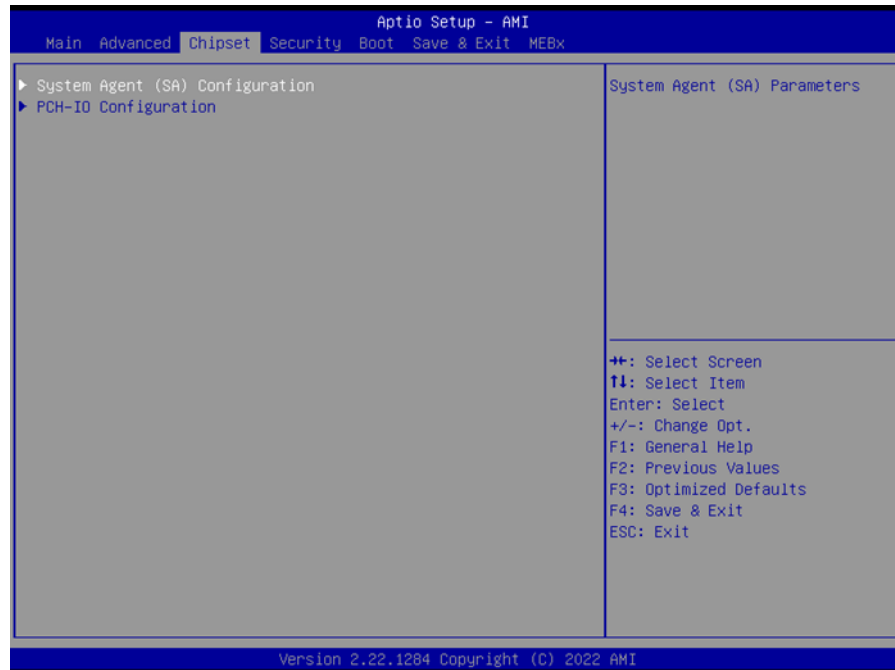
- **CSM Support**
Enable/Disable CSM Support.
- **GateA20 Active**
UPON REQUEST - GA20 can be disabled using BIOS services. ALWAYS - do not allow disabling GA20; this option is useful when any RT code is executed above 1MB.
- **INT19 Trap Response**
BIOS reaction on INT19 trapping by Option ROM: IMMEDIATE - execute the trap right away; POSTPONED - execute the trap during legacy boot.
- **Boot option filter**
This option controls Legacy/UEFI ROM priority.
- **Network**
Controls the execution of UEFI and Legacy PXE OpROM.
- **Storage**
Controls the execution of UEFI and Legacy Storage OpROM.
- **Video**
Controls the execution of UEFI and Legacy Video OpROM.
- **Other PCI devices**
Determines OpROM execution policy for devices other than Network, Storage, or Video.

4.1.2.14 NVMe Configuration

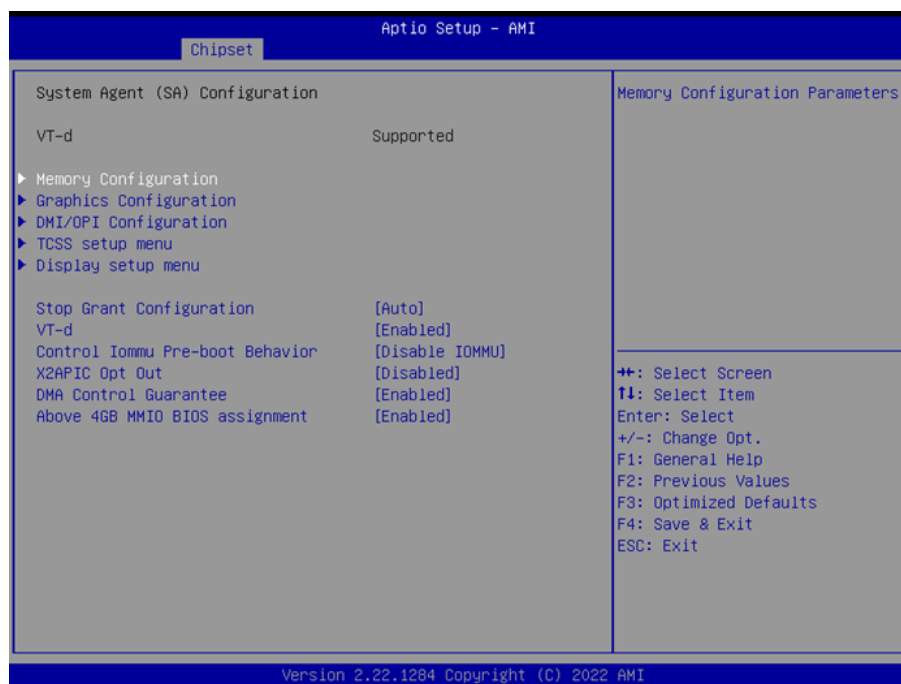


4.1.3 Chipset Configuration

Select the Chipset tab from the MIO-5377 setup screen to enter the Chipset BIOS setup screen. You can display a Chipset BIOS setup option by highlighting it using the <Arrow> keys. All Plug and Play BIOS Setup options are described in this section. The Plug and Play BIOS setup screen is shown below.

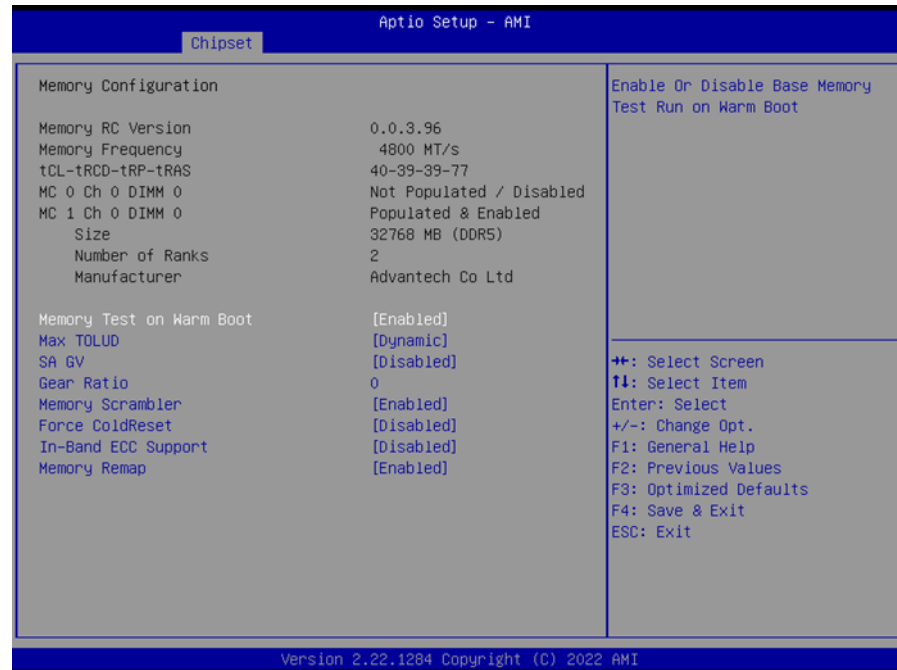


4.1.3.1 System Agent (SA) Configuration



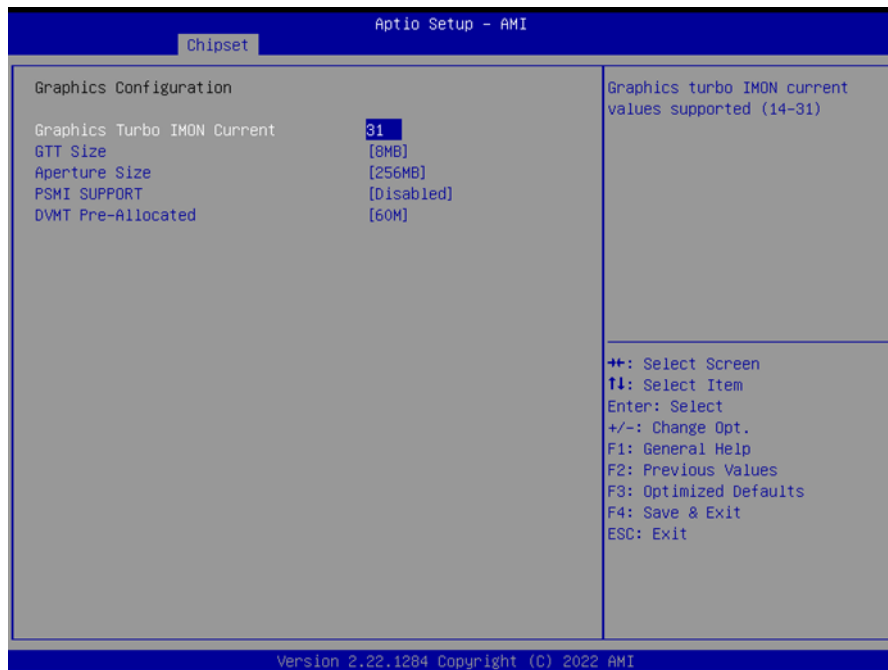
- **Memory Configuration**
Memory Configuration Parameters.
- **Graphics Configuration**
Graphics Configuration Parameters.
- **DMI/OPI Configuration**
Control various DMI functions.
- **TCSS setup menu**
TCSS configuration settings.
- **Display setup menu**
Display configuration settings.
- **Stop Grant Configuration**
Automatic/Manual stop grant configuration.
- **VT-d**
VT-D capability.
- **Control Iommu Pre-boot Behavior**
Enable IOMMU in pre-boot environment.
- **X2APIC Opt Out**
Enable/Disable X2APIC Opt Out Bit.
- **DMA Control Guarantee**
Enable/Disable DMA_CONTROL_GUARANTEE bit.
- **Above 4GB MMIO BIOS assignment**
Enable/Disable above 4GB Memory Mapped IO BIOS assignment.

4.1.3.1.1 Memory Configuration



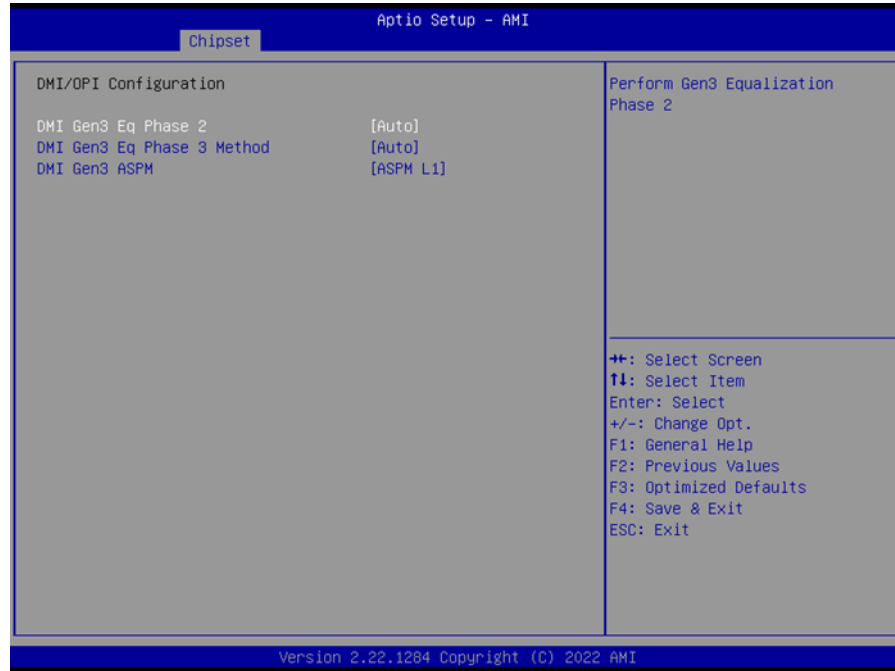
- **Memory Test on Warm Boot**
Enable/Disable Base Memory Test Run on Warm Boot.
- **Max TOLUD**
Maximum Value of TOLUD.
- **SA GV**
System Agent Geyserville.
- **Gear Ratio**
Gear ratio when SAGV is disabled.
- **Memory Scrambler**
Enable/Disable Memory Scrambler support.
- **Force ColdReset**
Force ColdReset OR Choose MrcColdBoot mode.
- **In-Band ECC Support**
Enable/Disable In-Band ECC.
- **Memory Remap**
Enable/Disable Memory Remap above 4GB.

4.1.3.1.2 Graphics Configuration



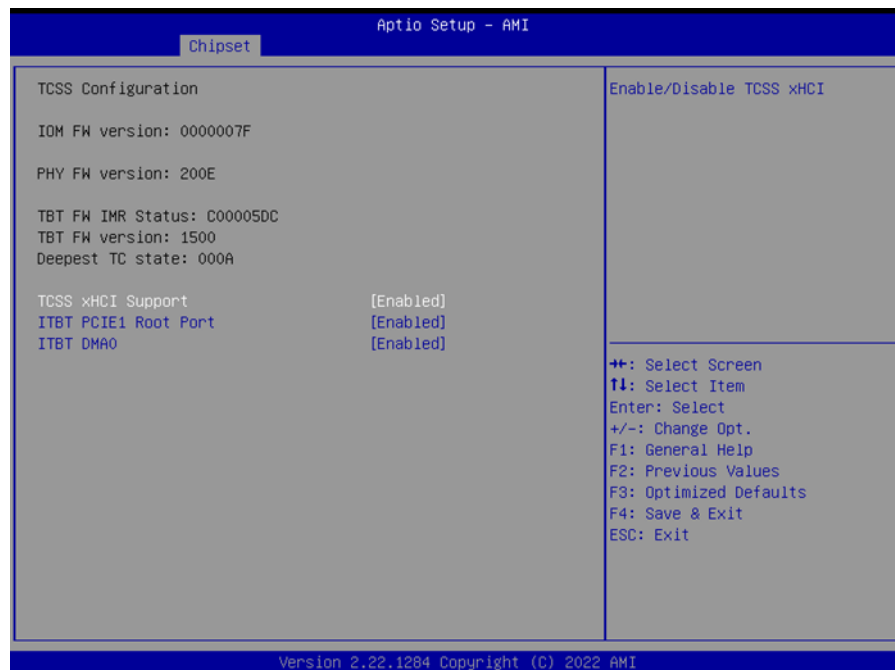
- **Graphics Turbo IMON Current**
Graphics turbo IMON current values supported.
- **GTT Size**
Select the GTT Size.
- **Aperture Size**
Select the Aperture Size.
- **PSMI Support**
Enable/Disable PSMI.
- **DVMT Pre-Allocated**
Select DVMT 5.0 Pre-Allocated (Fixed) Graphics Memory size used by the Internal Graphics Device.

4.1.3.1.3 DMI/OPI Configuration



- **DMI Gen3 Eq Phase 2**
Perform Gen3 Equalization Phase 2.
- **DMI Gen3 Eq Phase 3 Method**
Select Method for Gen3 Equalization Phase 3.
- **DMI Gen3 ASPM**
DMI Gen3 ASPM Support.

4.1.3.1.4 TCSS Setup Menu



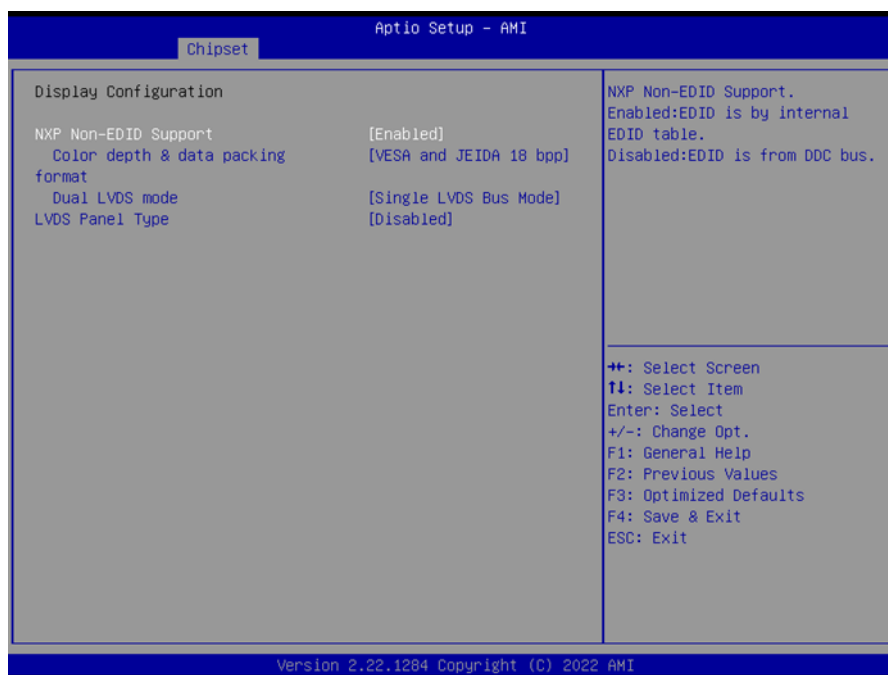
- **TCSS xHCI Support**
Enable/Disable TCSS xHCI.
- **ITBT PECI1 Root Port**

Enable/Disable ITBT PCIE Root.

- **ITBT DMA0**

Enable/Disable ITBT DMA0.

4.1.3.1.5 Display Setup Menu



- **NXP Non-EDID Support**

Non-EDID Support.

- **Color Depth & Data Packing**

Color depth and data packing format for Non-EDID support.

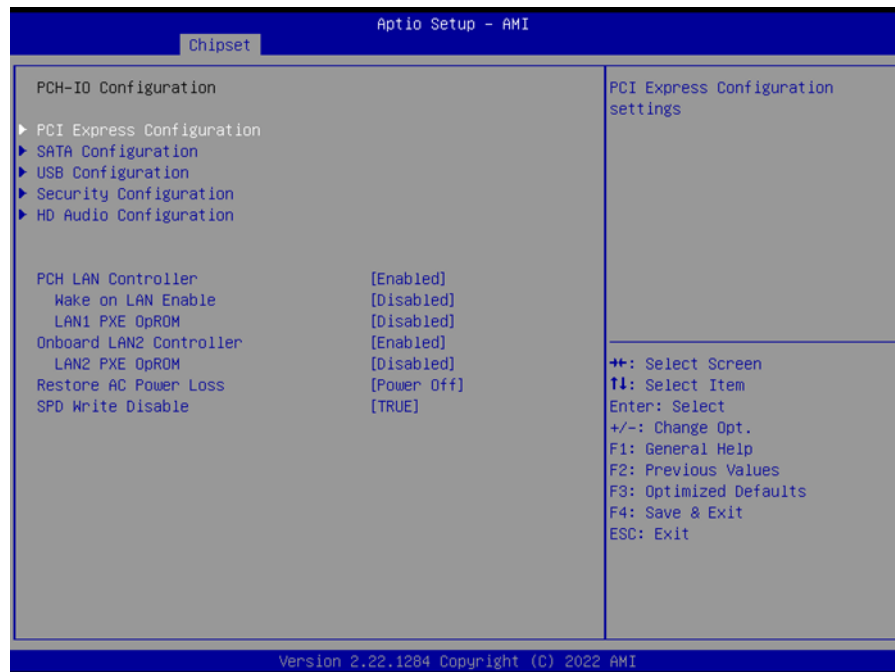
- **Dual LVDS Mode**

Select LVDS bus to Single bus mode or Dual bus mode.

- **LVDS Panel Type**

This item allows the user to select the LVDS panel resolution type.

4.1.3.2 PCH-IO Configuration



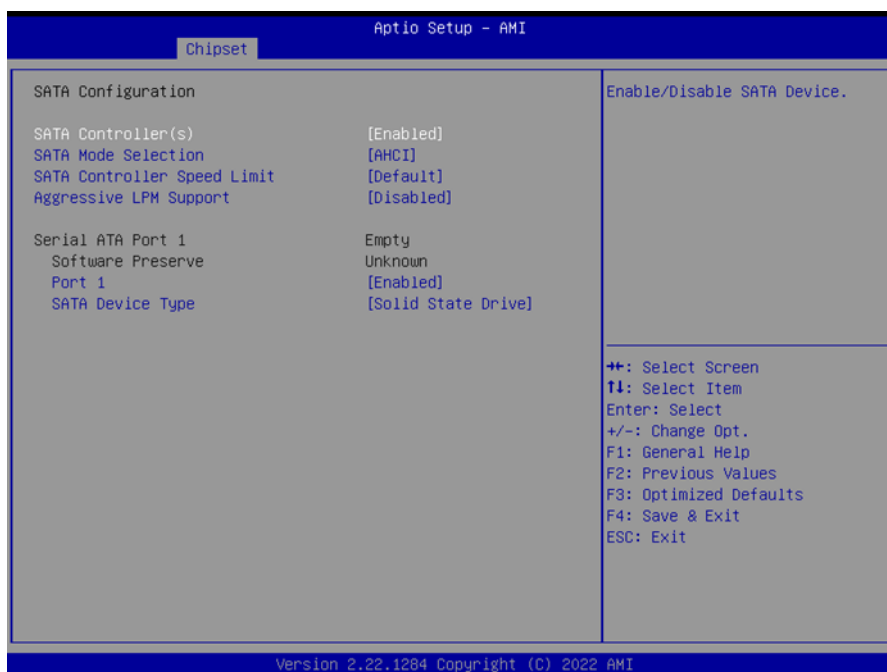
- **PCI Express Configuration**
PCI Express configuration settings.
- **SATA Configuration**
SATA Device options settings.
- **USB Configuration**
USB configuration settings.
- **Security Configuration**
Security configuration settings.
- **HD Audio Configuration**
HD Audio Subsystem configuration settings.
- **PCH LAN Controller**
Enable or Disable onboard NIC.
- **Wake on LAN Enable**
Enable or Disable Integrated LAN to wake the system.
- **LAN1 PXE ROM**
Enable or Disable boot option for LAN1 Controller.
- **Onboard LAN2 Controller**
Enable or Disable onboard LAN2 Controller.
- **LAN2 PXE ROM**
Enable or Disable boot option for LAN2 Controller.
- **Restore AC Power Loss**
Specify what state to go to when power is re-applied after a power failure (G3 state).
- **SPD Write Disable**
Enable/Disable SPD Write

4.1.3.2.1 PCI Express Configuration



- **DMI Link ASPM Control**
This item controls Active State Power Management of the DMI Link.
- **PCI Express Root Port 5/12**
PCI Express Port 5/12 Settings.

4.1.3.2.2 SATA Configuration



- **SATA Controller(s)**
Enable/Disable SATA Device.
- **SATA Mode Selection**
Determine how the SATA controller operates.
- **SATA Controller Speed Limit**

Indicates the maximum speed the SATA controller can support.

- **Aggressive LPM Support**

Enable PCH to aggressively enter link power state.

4.1.3.2.3 USB Configuration



- **USB2 PHY Sus Well Power Gating**

Select 'Enabled' to enable SUS Well PG for USB2 PHY.

- **USB Overcurrent**

Select 'Enabled' if Overcurrent functionality is used.

- **USB Overcurrent Lock**

Select 'Enabled' if Overcurrent functionality is used.

- **USB3.1 Speed Selection**

USB3.1 Speed selection; GEN1 or GEN2.

- **USB Port Disable Override**

Selectively Enable/Disable the corresponding USB Port from reporting a Device Connection to the Controller.

4.1.3.2.4 Security Configuration



- **RTC Memory Lock**
Enable will lock bytes 38h-3Fh in the lower/upper 128-byte bank of RTC RAM.
- **BIOS Lock**
Enable or Disable the PCH BIOS Lock Enable feature.
- **Force unlock on all GPIO pads**
If Enabled BIOS will force all GPIO pads to be in the unlock state.

4.1.3.2.5 HD Audio Configuration



- **HD Audio**
Control Detection of the HD-Audio device. Disabled = HDA will be unconditionally disabled. Enabled = HDA will be unconditionally Enabled.

4.1.3.2.6 Serial IO Configuration



- **I2C0/I2C1 Controller**
Enable/Disable Serial IO Controller.
- **Serial IO I2C0/I2C1 Settings**
Configure Serial IO Controller.
- **Serial IO timing parameters**
Enable additional timing parameters for all Serial IO controllers.

4.1.4 Security



Select Security Setup from the MIO-5377 setup main BIOS setup menu. All Security setup options, such as password protection and virus protection are described in this

section. To access the sub-menu for the following items, select the item and press <Enter>:

- **Change Administrator / User Password**
Select this option and press <ENTER> to access the sub-menu, and then type in the password.
- **Secure Boot**
Secure Boot Configuration.

4.1.5 Boot



- **Setup Prompt Timeout**
Number of seconds that the firmware will wait before initiating the original default boot selection. A value of 0 indicates that the default boot selection is to be initiated immediately on boot. A value of 65535(0xFFFF) indicates that firmware will wait for user input before booting. This means the default boot selection is not automatically started by the firmware.
- **Bootup NumLock State**
Select the keyboard NumLock state.
- **Quiet Boot**
Enables or Disables the Quiet Boot option.
- **Boot Option #1**
Sets the system boot order.
- **Fast Boot**
Enables or Disables boot with initialization of a minimal set of devices required to launch the active boot option. Has no effect on BBS boot options.

4.1.6 Save & Exit



- **Save Changes and Exit**
This item allows you to exit system setup after saving the changes.
- **Discard Changes and Exit**
This item allows you to exit system setup without saving any changes.
- **Save Changes and Reset**
This item allows you to reset the system after saving the changes.
- **Discard Changes and Reset**
This item allows you to reset system setup without saving any changes.
- **Save Changes**
This item allows you to save changes done so far to any of the options.
- **Discard Changes**
This item allows you to discard changes done so far to any of the options.
- **Restore Defaults**
This item allows you to restore/load default values for all the options.
- **Save as User Defaults**
This item allows you to save the changes done so far as user defaults.
- **Restore User Defaults**
This item allows you to restore the user defaults to all the options.
- **Boot Override**
Boot device select can override your boot priority.

Appendix **A**

A.1 System I/O Ports

Addr. Range (Hex)	Device
00h-1Fh	DMA Controller
20h-2Dh	Interrupt Controller
2Eh-2Fh	Motherboard resources
30h-3Dh	Interrupt Controller
40h-43h	Timer/Counter
4Eh-4Fh	Motherboard resources
50h-53h	Timer/Counter
60h-6Fh	8042 (keyboard controller)/NMI Controller/Microcontroller
70h-7Fh	Real-time Controller
80h-8Fh	Debug Port/Reserved
90h-9Fh	Debug Port/Reset Generator
A0h-ADh	Interrupt Controller
B0h-B1h	Interrupt Controller
B4h-BDh	Power Management
200h-27Fh	CANBus Controller
280h-28Fh	I2C Controller
290h-29Fh	EC Index port and Data port
2A0h-2BFh	GPIO Controller
2C0h-2DFh	SMBus Controller
2E8h-2EFh	Communications Port (COM4)
2F0h-2F7h	EC/PMC Controller
2F8h-2FFh	Communications Port (COM2)
300h-37Fh	CANBus Controller
3E8h-3EFh	Communications Port (COM3)
3F8h-3FFh	Communications Port (COM1)
480h-4CFh	Motherboard resources
4D0h-4D1h	Interrupt Controller
680h-69Fh	Motherboard resources
A00h-AFFh	Motherboard resources
164Eh-164Fh	Motherboard resources
1800h-18FFh	Motherboard resources
CF9h-CF9h	Reset Generator

A.2 DMA Channel Assignments

Channel	Function
0	Available
1	Available
2	Available
3	Available
4	Direct memory access controller
5	Available
6	Available
7	Available

A.3 1st MB Memory Map

Addr. Range (Hex)	Device
E0000h - FFFFFh	System board
D0000h - DFFFFh	PCI Bus
C0000h - CFFFFh	System board
A0000h - BFFFFh	PCI Bus
A0000h - BFFFFh	Intel® HD Graphic
00000h - 9FFFFh	System board

A.4 Interrupt Assignments

Interrupt#	Interrupt source
NMI	Parity error detected
IRQ0	System timer
IRQ1	Using SERIRQ, Keyboard Emulation
IRQ2	Interrupt from controller 2 (cascade)
IRQ3	Communications Port (COM2)
IRQ4	Communications Port (COM1)
IRQ5	EC Watch Dog
IRQ6	CANBus Controller
IRQ7	Communications Port (COM3)
IRQ8	System CMOS/real time clock
IRQ9	Microsoft ACPI-Compliant System
IRQ10	Communications Port (COM4)
IRQ11	Display Controller
IRQ12	Available
IRQ13	Numeric data processor
IRQ14	GPIO Controller
IRQ15	Reserved

ADVANTECH

Enabling an Intelligent Planet

www.advantech.com

Please verify specifications before quoting. This guide is intended for reference purposes only.

All product specifications are subject to change without notice.

No part of this publication may be reproduced in any form or by any means, such as electronically, by photocopying, recording, or otherwise, without prior written permission from the publisher.

All brand and product names are trademarks or registered trademarks of their respective companies.

© Advantech Co., Ltd. 2023

Our company network supports you worldwide with offices in Germany, Austria, Switzerland, the UK and the USA. For more information please contact:

Headquarters

Germany



FORTEC
GROUP

FORTEC Elektronik AG
Augsburger Str. 2b
82110 Germering

Phone: +49 89 894450-0
E-Mail: info@fortecag.de
Internet: www.fortecag.de

Fortec Group Members

Austria



FORTEC
INTEGRATED

Distec GmbH Office Vienna
Nuschinggasse 12
1230 Wien

Phone: +43 1 8673492-0
E-Mail: info@distec.de
Internet: www.distec.de

Germany



FORTEC
INTEGRATED

Distec GmbH
Augsburger Str. 2b
82110 Germering

Phone: +49 89 894363-0
E-Mail: info@distec.de
Internet: www.distec.de

Switzerland



ALTRAC
A FORTEC GROUP MEMBER

ALTRAC AG
Bahnhofstraße 3
5436 Würenlos

Phone: +41 44 7446111
E-Mail: info@altrac.ch
Internet: www.altrac.ch

United Kingdom



FORTEC
UNITED KINGDOM

Display Technology Ltd.
Osprey House, 1 Osprey Court
Hinchingbrooke Business Park
Huntingdon, Cambridgeshire, PE29 6FN

Phone: +44 1480 411600
E-Mail: info@displaytechnology.co.uk
Internet: www.displaytechnology.co.uk

USA



 **APOLLO DISPLAY**
TECHNOLOGIES
A FORTEC GROUP MEMBER

Apollo Display Technologies, Corp.
87 Raynor Avenue, Unit 1
Ronkonkoma, NY 11779

Phone: +1 631 5804360
E-Mail: info@apolloDisplays.com
Internet: www.apolloDisplays.com