



OUR GLOBAL
COMPETENCE
CENTRES

 APOLLO DISPLAY
TECHNOLOGIES



 DISTEC



 DISPLAY
TECHNOLOGY



Manual

congatec

conga-PA5

2,5" Pico-ITX Single-Board Computer with Intel Apollo Lake N4200, N3350, E39xx Processor

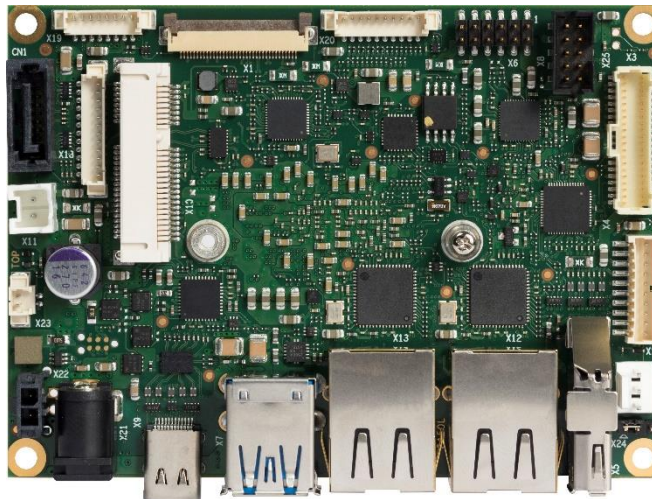

The information contained in this document has been carefully researched and is, to the best of our knowledge, accurate. However, we assume no liability for any product failures or damages, immediate or consequential, resulting from the use of the information provided herein. Our products are not intended for use in systems in which failures of product could result in personal injury. All trademarks mentioned herein are property of their respective owners. All specifications are subject to change without notice.

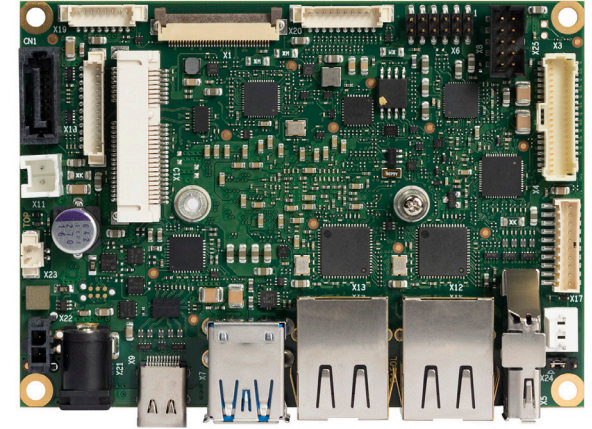

conga-PA5 Pico-ITX SBC

Detailed Description Of The congatec Pico-ITX Based On 5th Generation Intel® Atom®, Celeron® and Pentium®

User's Guide

Revision 1.9

Revision History

Revision	Date (yyyy.mm.dd)	Author	Changes
0.1	2017.03.17	BEU	<ul style="list-style-type: none"> Preliminary release
1.0	2017.09.11	BEU	<ul style="list-style-type: none"> Minor improvements throughout the document Updated image of conga-PA5 on title page Added LVDS, backlight, and new USB cable in section 1.2.3 "Optional Cables" Changed SPI flash size to 8 MB in section 2 "Feature Summary" Included power consumption measurements in section 2.5 "Power Consumption" and 2.6 "Supply Voltage Battery Power" Added caution about correct orientation of the cooling solutions and updated images in section 4 "Cooling Solution" Changed connectors in section 5.4.3 "USB 2.0 Header", 5.7.2 "LVDS Header", and 5.7.2.1 "Backlight Power Header" Added note about maximum current draw in section 5.7.2 "LVDS Header" Changed fuse limit to 500 mA in section 6.1.2 "I2C and Watchdog" and 6.1.3 "GPIOs" Updated connectors in section 7 "Mechanical Drawing" Included information in section 8 "BIOS Setup Description"
1.1	2018.01.08	BEU	<ul style="list-style-type: none"> Updated supported OS in section 2.2 "Supported Operating Systems" Added caution about maximum cable length of USB 2.0 devices in section 5.3 "USB Connectors" Updated security features in table 6 "Feature Summary" and section 6.9 "Security Features"
1.2	2018.06.25	BEU	<ul style="list-style-type: none"> Added errata as a document to read in the preface section Updated "Electrostatic Sensitive Device" information on page 3 Updated section 5.1.3 "USB Type-C™ Port" Included information about Wake-on-LAN support in section 5.4 "Gigabit Ethernet Ports" Updated section 5.7 "UART Headers"
1.3	2018.08.21	BEU	<ul style="list-style-type: none"> Updated information throughout the document
1.4	2018.10.15	BEU	<ul style="list-style-type: none"> Corrected TPM in table 6 "Feature Summary" and section 6.9 "Security Features" Added borehole versions of heatspreaders to section 1.2.2 "Optional Accesories" and 4 "Cooling Solution" Added possible mating connectors
1.5	2018.11.27	BEU	<ul style="list-style-type: none"> Added a new commercial variant to table 1 and table 8 Added S3 and S5 power consumption values to table 8 Added more cautions and information about correct orientation of the cooling solutions in section 4 "Cooling Solution" Added information about termination in table 5 and section 5.7 "UART Headers" Added new section 5.8 "MIPI CSI-2 (Camera)"
1.6	2019.01.23	BEU	<ul style="list-style-type: none"> Added note to the USB 2.0 adapter cable (14000210) in table 5 Added note to use ODD pins for single channel LVDS panel in section 5.6.2 "LVDS/eDP Header"
1.7	2019.05.29	BEU	<ul style="list-style-type: none"> Updated note in section 4 "Cooling Solutions" Added power consumption values for new variant 048122 and corrected S3 and S5 in table 8
1.8	2020.01.07	BEU	<ul style="list-style-type: none"> Corrected cable length of item 14000147 in table 5 Updated section 4 "Cooling Solutions" Added reference to BIOS Setup Description application note in section 8 "BIOS Setup Description" Updated section 8.3 "Updating the BIOS" Updated supported flash device in section 8.4 "Support Flash Devices" Updated section 9 "Industry Specifications"
1.9	2020.03.17	BEU	<ul style="list-style-type: none"> Updated accessories in tables 3, 4, and 5 and combined them under section 1.2.3 "Optional accessories" Removed table with cooling solutions from section 4 "Cooling solutions" and linked to table 3 instead

Preface

This user's guide provides information about the components, features and connectors available on the conga-PA5 Pico-ITX Single Board Computer. This user's guide should be read in conjunction with the document "[Errata_congatec_xA5_designs](#)". Click on the document name to download it.

Disclaimer

The information contained within this user's guide, including but not limited to any product specification, is subject to change without notice.

congatec AG provides no warranty with regard to this user's guide or any other information contained herein and hereby expressly disclaims any implied warranties of merchantability or fitness for any particular purpose with regard to any of the foregoing. congatec AG assumes no liability for any damages incurred directly or indirectly from any technical or typographical errors or omissions contained herein or for discrepancies between the product and the user's guide. In no event shall congatec AG be liable for any incidental, consequential, special, or exemplary damages, whether based on tort, contract or otherwise, arising out of or in connection with this user's guide or any other information contained herein or the use thereof.

Intended Audience

This user's guide is intended for technically qualified personnel. It is not intended for general audiences.

Lead-Free Designs (RoHS)

All congatec AG products are created from lead-free components and are completely RoHS compliant.

Electrostatic Sensitive Device



All congatec AG products are electrostatic sensitive devices. They are enclosed in static shielding bags, and shipped enclosed in secondary packaging (protective packaging). The secondary packaging does not provide electrostatic protection.

Do not remove the device from the static shielding bag or handle it, except at an electrostatic-free workstation. Also, do not ship or store electronic devices near strong electrostatic, electromagnetic, magnetic, or radioactive fields unless the device is contained within its original packaging. Be aware that failure to comply with these guidelines will void the congatec AG Limited Warranty.

Symbols

The following symbols are used in this user's guide:



Warning

Warnings indicate conditions that, if not observed, can cause personal injury.



Caution

Cautions warn the user about how to prevent damage to hardware or loss of data.



Note

Notes call attention to important information that should be observed.



Connector Type

Describes the connector used on the Single Board Computer and a possible mating connector.

Copyright Notice

Copyright © 2017, congatec AG. All rights reserved. All text, pictures and graphics are protected by copyrights. No copying is permitted without written permission from congatec AG.

congatec AG has made every attempt to ensure that the information in this document is accurate yet the information contained within is supplied "as-is".

Trademarks

Product names, logos, brands, and other trademarks featured or referred to within this user's guide, or the congatec website, are the property of their respective trademark holders. These trademark holders are not affiliated with congatec AG, our products, or our website.

Warranty

congatec AG makes no representation, warranty or guaranty, express or implied regarding the products except its standard form of limited warranty ("Limited Warranty") per the terms and conditions of the congatec entity, which the product is delivered from. These terms and conditions can be downloaded from www.congatec.com. congatec AG may in its sole discretion modify its Limited Warranty at any time and from time to time.

The products may include software. Use of the software is subject to the terms and conditions set out in the respective owner's license agreements, which are available at www.congatec.com and/or upon request.

Beginning on the date of shipment to its direct customer and continuing for the published warranty period, congatec AG represents that the products are new and warrants that each product failing to function properly under normal use, due to a defect in materials or workmanship or due to non conformance to the agreed upon specifications, will be repaired or exchanged, at congatec's option and expense.

Customer will obtain a Return Material Authorization ("RMA") number from congatec AG prior to returning the non conforming product freight prepaid. congatec AG will pay for transporting the repaired or exchanged product to the customer.

Repaired, replaced or exchanged product will be warranted for the repair warranty period in effect as of the date the repaired, exchanged or replaced product is shipped by congatec, or the remainder of the original warranty, whichever is longer. This Limited Warranty extends to congatec's direct customer only and is not assignable or transferable.

Except as set forth in writing in the Limited Warranty, congatec makes no performance representations, warranties, or guarantees, either express or implied, oral or written, with respect to the products, including without limitation any implied warranty (a) of merchantability, (b) of fitness for a particular purpose, or (c) arising from course of performance, course of dealing, or usage of trade.

congatec AG shall in no event be liable to the end user for collateral or consequential damages of any kind. congatec shall not otherwise be liable for loss, damage or expense directly or indirectly arising from the use of the product or from any other cause. The sole and exclusive remedy against congatec, whether a claim sound in contract, warranty, tort or any other legal theory, shall be repair or replacement of the product only.

Certification

congatec AG is certified to DIN EN ISO 9001 standard.



Technical Support

congatec AG technicians and engineers are committed to providing the best possible technical support for our customers so that our products can be easily used and implemented. We request that you first visit our website at www.congatec.com for the latest documentation, utilities and drivers, which have been made available to assist you. If you still require assistance after visiting our website then contact our technical support department by email at support@congatec.com

Terminology

Term	Description
PCIe	Peripheral Component Interface Express
cBC	congatec Board Controller
SDIO	Secure Digital Input Output
USB	Universal Serial Bus
SATA	Serial AT Attachment: serial-interface standard for hard disks
HDA	High Definition Audio
S/PDIF	Sony/Philips Digital Interconnect Format
HDMI	High Definition Multimedia Interface
TMDS	Transition Minimized Differential Signaling
DVI	Digital Visual Interface
LPC	Low Pin-Count
I ² C Bus	Inter-Integrated Circuit Bus
SM Bus	System Management Bus
SPI	Serial Peripheral Interface
GbE	Gigabit Ethernet
LVDS	Low-Voltage Differential Signaling
DDC	Display Data Channel is an I ² C bus interface between a display and a graphics adapter.
PN	Part Number - the part number for placing orders.
N.C	Not connected
N.A	Not available
TBD	To be determined

Contents

1	Introduction	10	5.5.2	2-Pin SATA Power Connector	29
1.1	Pico-ITX Concept.....	10	5.5.3	mSATA Card Slot.....	29
1.2	conga-PA5.....	10	5.6	Display Interfaces.....	30
1.2.1	Options Information.....	11	5.6.1	DP++ Port.....	30
1.2.2	Optional Accessories	13	5.6.2	LVDS/eDP Header.....	31
2	Specification	14	5.6.2.1	Backlight Power Header	32
2.1	Feature List	14	5.6.2.2	Panel Power Jumper	32
2.2	Supported Operating Systems	15	5.7	COM Headers.....	33
2.3	Mechanical Dimensions	15	5.8	MIPI CSI-2 (Camera).....	34
2.4	Supply Voltage Power.....	15	5.9	mPCIe / mSATA Card Slot.....	36
2.5	Power Consumption	15	6	Additional Features.....	37
2.6	Supply Voltage Battery Power	17	6.1	Feature Connectors and Micro-SD Card Slot	37
2.7	Environmental Specifications.....	17	6.1.1	Buttons and LEDs	37
3	Block Diagram.....	18	6.1.2	I2C and Watchdog.....	38
4	Cooling Solutions.....	19	6.1.3	GPIOs.....	39
4.1	CSP Dimensions	20	6.1.4	Micro-SD Card Slot	40
4.2	HSP Dimensions.....	22	6.2	congatec Board Controller (cBC)	40
5	Connector Description.....	24	6.2.1	Fan Control	40
5.1	Power Supply Connectors.....	24	6.2.2	Power Loss Control	40
5.1.1	DC Power Jack.....	24	6.2.3	Board Information	40
5.1.2	2-Pin Power Connector	24	6.2.4	CPU Fan Header	41
5.1.3	USB Type-C™ Port.....	25	6.3	OEM BIOS Customization.....	41
5.1.4	Power Status LED.....	25	6.3.1	OEM Default Settings	41
5.1.5	CR2032 / BR2330A Cell Battery Header.....	25	6.3.2	OEM Boot Logo.....	41
5.2	High Definition Audio Header	26	6.3.3	OEM POST Logo	42
5.3	USB Connectors.....	27	6.3.4	OEM BIOS Code/Data.....	42
5.3.1	USB 3.0 Ports	27	6.3.5	OEM DXE Driver	42
5.3.2	USB Type-C™ Port.....	27	6.4	congatec Battery Management Interface	42
5.3.3	USB 2.0 Header	28	6.5	API Support (CGOS)	43
5.4	Gigabit Ethernet Ports	28	6.6	GPIOs.....	43
5.5	SATA Connectors	29	6.7	Thermal/Voltage Monitoring.....	43
5.5.1	SATA / SATADOM Port	29	6.8	External System Wake Event	43
			6.9	Security Features.....	43
			7	Mechanical Drawing	44

8	BIOS Setup Description	45
8.1	Navigating the BIOS Setup Menu	45
8.2	BIOS Versions.....	45
8.3	Updating the BIOS.....	46
8.4	Supported Flash Device.....	46
9	Industry Specifications	47

List of Tables

Table 1	conga-PA5 Commercial Variants.....	11
Table 2	conga-PA5 Industrial Variants	12
Table 3	Cooling Solutions.....	13
Table 4	Cables.....	13
Table 5	Power Supplies	13
Table 6	Feature Summary.....	14
Table 7	Measurement Description.....	16
Table 8	Power Consumption Values	16
Table 9	CMOS Battery Power Consumption	17
Table 10	X21 Pinout Description	24
Table 11	X22 Pinout Description	24
Table 12	Power Status LED State Description	25
Table 13	X23 Pinout Description	25
Table 14	X6 Pinout Description	26
Table 15	X8 Pinout Description	28
Table 16	Gigabit Ethernet Port LEDs Description	28
Table 17	X11 Pinout Description	29
Table 18	X3 Pinout Description	31
Table 19	X4 Pinout Description	32
Table 20	X24 Pinout Description	32
Table 21	X15, X16 Pinout Description.....	33
Table 22	X1 Pinout Description	34
Table 23	X10 Pinout Description	36
Table 24	X18 Pinout Description	37
Table 25	X19 Pinout Description	38
Table 26	X20 Pinout Description	39
Table 27	X17 Pinout Description	41
Table 28	References	47

1 Introduction

1.1 Pico-ITX Concept

The Pico-ITX form factor provides system designers and manufacturers with a standardized ultra compact platform for development. With a footprint of 100mm x 72mm, this scalable platform promotes the design of highly integrated, energy efficient systems. Due to its small size, the Pico-ITX form factor enables PC appliance designers not only to design attractive low cost devices but also allows them to explore a huge variety of product development options - from compact space-saving designs to fully functional Information Station and Value PC systems. This helps to reduce product design cycle and encourages rapid innovation in system design, to meet the ever-changing needs of the market.

Additionally, the boards can be passively cooled, presenting opportunities for fanless designs. The Pico-ITX boards are equipped with various interfaces such as PCI Express, SATA, USB 2.0/3.0, Ethernet, Displays and Audio.

1.2 conga-PA5

The conga-PA5 is a Single Board Computer design based on the Pico-ITX specification. The conga-PA5 SBC features the Intel® 5th generation Atom®, Celeron® and Pentium® processors. With maximum 12 W TDP processors, the SBC offers Ultra Low Power boards with high computing performance and outstanding graphics. Additionally, the SBC supports onboard LPDDR4 memory up to 2400 MT/s, maximum system memory capacity of 8 GB, multiple I/O interfaces, up to three independent displays and various congatec embedded features.

With smaller board size and lower height keep-out zones, the conga-PA5 SBC provides manufacturers and system designers with the opportunity to design compact systems for space restricted areas.

The various features and capabilities offered by the conga-PA5 makes it ideal for the design of compact, energy efficient, performance-oriented embedded systems.

1.2.1 Options Information

The conga-PA5 is currently available in ten variants. This user's guide describes all of these variants. The tables below show the different configurations available. Check for the Part-No. that applies to your product. This will tell you what options described in this user's guide are available on your particular module.

Table 1 conga-PA5 Commercial Variants

PN	048100	048101	048102	048120	048121	048123
Intel Processor	Atom® x7-E3950 Quad Core 1.6 GHz	Atom® x5-E3940 Quad Core 1.6 GHz	Atom® x5-E3930 Dual Core 1.3 GHz	Pentium® N4200 Quad Core 1.1 GHz	Celeron® N3350 Dual Core 1.1 GHz	Pentium® N4200 Quad Core 1.1 GHz
L2 Cache	2 MB	2 MB	2 MB	2 MB	1 MB	2 MB
Burst Frequency	2.0 GHz	1.8 GHz	1.8 GHz	2.5 GHz	2.4 GHz	2.5 GHz
Onboard Memory	8 GB 2400 MT/s	4 GB 2133 MT/s	4 GB 2133 MT/s	8 GB 2400 MT/s	4 GB 2400 MT/s	4 GB 2400 MT/s
Processor Graphics	Intel® HD Graphics 505	Intel® HD Graphics 500	Intel® HD Graphics 500	Intel® HD Graphics 505	Intel® HD Graphics 500	Intel® HD Graphics 505
Graphics Base / Burst	500/650 MHz	400/600 MHz	400/550 MHz	200/750 MHz	200/650 MHz	200/750 MHz
LVDS	Single/Dual 18/24-bit	Single/Dual 18/24-bit	Single/Dual 18/24-bit	Single/Dual 18/24-bit	Single/Dual 18/24-bit	Single/Dual 18/24-bit
DDI	DisplayPort++	DisplayPort++	DisplayPort++	DisplayPort++	DisplayPort++	DisplayPort++
Processor TDP (Max)	12 W	9.5 W	6.5 W	6 W	6 W	6 W

PN	048122
Intel Processor	Celeron® J3455 Quad Core 1.5 GHz
L2 Cache	2 MB
Burst Frequency	2.3 GHz
Onboard Memory	4 GB 2133 MT/s
Processor Graphics	Intel® HD Graphics 500
Graphics Base / Burst	250/750 MHz
LVDS	Single/Dual 18/24-bit
DDI	DisplayPort++
Processor TDP (Max)	10 W

Table 2 conga-PA5 Industrial Variants

PN	048110	048111	048112
Intel Processor	Atom® x7-E3950 Quad Core 1.6 GHz	Atom® x5-E3940 Quad Core 1.6 GHz	Atom® x5-E3930 Dual Core 1.3 GHz
L2 Cache	2 MB	2 MB	2 MB
Burst Frequency	2.0 GHz	1.8 GHz	1.8 GHz
Onboard Memory	8 GB 2400 MT/s	4 GB 2133 MT/s	4 GB 2133 MT/s
Processor Graphics	Intel® HD Graphics 505	Intel® HD Graphics 500	Intel® HD Graphics 500
Graphics Base / Burst	500/650 MHz	400/600 MHz	400/550 MHz
LVDS	Single/Dual 18/24-bit	Single/Dual 18/24-bit	Single/Dual 18/24-bit
DDI	DisplayPort++	DisplayPort++	DisplayPort++
Processor TDP (Max)	12 W	9.5 W	6.5 W

1.2.2 Optional Accessories

Table 3 Cooling Solutions

Article	PN	Description
conga-PA5/HSP-T	048150	Heatspreader solution for conga-PA5 based on Pentium and Celeron processors. All standoffs are with M2.5 thread.
conga-PA5/i-HSP-T	048151	Heatspreader solution for conga-PA5 based on Atom E39xx processors. All standoffs are with M2.5 thread.
conga-PA5/CSP-T	048152	Passive cooling solution for conga-PA5 based on Pentium and Celeron processors and heat sink with 12mm heatsink fins. All standoffs are with M2.5 thread.
conga-PA5/i-CSP-T	048153	Passive cooling solution for conga-PA5 based on Atom E39xx processors with 12mm heatsink fins. All standoffs are with M2.5 thread.
conga-PA5/HSP-B	048154	Heatspreader solution for conga-PA5 based on Pentium and Celeron processors. All standoffs are with 2.7mm bore hole.
conga-PA5/i-HSP-B	048155	Heatspreader solution for conga-PA5 based on Atom E39xx processors. All standoffs are with 2.7mm bore hole.

Table 4 Cables

Article	PN	Description
conga-PA5 Cable Kit	14000203	Cable Kit for conga-PA5 containing cab-Pico-ITX-USB2.0-Twin, cab-Pico-ITX-Audio Cable Adapter, cab-Pico-ITX-Buttons-LED, cab-Pico-ITX-GPIO, cab-Pico-ITX-RS232, cab-Pico-ITX-RS485, cab-Pico-ITX-External-Power, cab-Pico-ITX-Feature, cab-Pico-ITX-SATA-Power, SATA Cable and Mini-PCIe full-size card extender
cab-Pico-ITX-LVDS	14000211	LVDS data cable for Pico-ITX to connect LCD panel AUO G170EG01 V.1 (panel part number #10000132 17" LVDS Panel G170EG01 V.1)
cab-Pico-ITX-Backlight	14000206	Backlight power cable for Pico-ITX to connect LCD panel AUO G170EG01 V.1 (panel part number #10000132 17" LVDS Panel G170EG01 V.1)
cab-Pico-ITX-RS232	14000152	RS232 internal cable adapter, DSUB9 male, length 150mm
cab-Pico-ITX-RS422	14000153	RS422 cable adapter, DSUB9 male, length 150mm
cab-Pico-ITX-RS485	14000154	RS485 cable adapter, DSUB9 male, length 150mm
cab-Pico-ITX-GPIO	14000151	GPIO cable, free end, length 150 mm
cab-Pico-ITX-Buttons-LED	14000147	Buttons and LEDs cable, length 150 mm
cab-Pico-ITX-Power	14000172	Internal power cable for industrial versions of conga-PA5, length 150 mm

Table 5 Power Supplies

Article	PN	Description
Power Supply 40W	10000238	PSU, 40W, 12V / 3.33A, Plug 5.5x2.5mm / 9.5mm length
Power Supply 60W	10000239	PSU, 60W, 12V / 5A, Plug 5.5x2.5mm / 10mm length

2 Specification

2.1 Feature List

Table 6 Feature Summary

Form Factor	Based on Pico-ITX form factor (100 x 72 mm)	
Processor	Intel® 5 th Generation Intel® Atom®, Pentium® and Celeron® SoC.	
Memory	Up to 4 Channels onboard LPDDR4 with up to 2400 MT/s, maximum system capacity 8 GB	
cBC	Multi-stage watchdog, manufacturing and board information, board statistics, I2C bus, Power loss control	
Chipset	Integrated in the SoC	
Audio	High Definition Audio Interface, Cirrus Logic CS4207	
Ethernet	2x LAN Gbit / 100 Mbit / 10 Mbit, Intel® Gigabit Ethernet i211 controller (i210 for industrial variants)	
Graphics	Intel® Gen 9 HD Graphics with support for DirectX12, OpenGL 4.3, OpenCL 1.2, OpenGLES 3.0, MPEG2 full HW acceleration with H.264 with L5.2 decode and encode, HEVC (H.265), VP8, VP9, PAVP 2.0, HDCP 1.4/2.0, MVC and supports up to 3x independent displays	
Graphic Interfaces	1x DP++, 1x DP via USB Type-C™ and either 1x LVDS (default) or 1x eDP 1.3	
Back Panel I/O Connectors	1x DC Power Jack (optional for industrial variants) 2x USB 3.0 Ports 1x USB Type-C™ Port	1x DP++ Port 2x Gigabit Ethernet Ports
Onboard I/O Connectors	1x 2-Pin Power Connector 1x CR2032 / BR2330A Cell Battery Header 1x High Definition Audio Header 1x USB 2.0 Header (for two additional USB 2.0 ports) 1x SATA / SATADOM Port 1x 2-Pin SATA Power Connector 1x mSATA Card Slot	1x Backlight Power Header 2x UART Headers 1x mPCIe / mSATA Card Slot 1x Micro-SD Card Slot 1x CPU Fan Header 3x Feature Connectors 1x MIPI CSI-2 Connector
Other Features	Thermal and voltage monitoring, RTC Battery, congatec standard BIOS	
BIOS	AMI Aptio® UEFI 5.x firmware, 8 MB SPI flash with congatec embedded BIOS features.	
Power Management	ACPI 4.0 compliant with battery support. Also supports Suspend to RAM (S3). Ultra low standby power consumption.	
Security	Integrated Intel® PTT (TPM 2.0). Infineon SLB9670 (SPI TPM 2.0).	



Note
Some of the features mentioned in the above feature summary are optional. Check the article number of your module and compare it to the options information list on page 11 of this user's guide to determine what options are available on your particular module.

2.2 Supported Operating Systems

The conga-PA5 supports the following operating systems.

- Calypso Island
- Microsoft® Windows® 10
- Microsoft® Windows® 10 IoT
- Linux 3.x/4.x
- Yocto 2.x

2.3 Mechanical Dimensions

- 100 mm x 72 mm
- 19 mm height

2.4 Supply Voltage Power

- 12 V DC \pm 10%



Caution

The absolute maximum rating of the input voltage is 13.2 volts. Do not exceed this rating or expose the conga-PA5 to the absolute maximum voltage for a prolonged time. The system may not function, may be damaged or may have reliability issues if you do not observe this warning information.

2.5 Power Consumption

The power consumption values were measured with the following setup:

- conga-PA5
- conga-PA5 cooling solution
- Microsoft® Windows® 10 (64-bit)



Note

The CPU was stressed to its maximum workload with the Intel® Thermal Analysis Tool

The power consumption values were recorded during the following system states:

Table 7 Measurement Description

System State	Description	Comment
S0: Minimum value	Lowest frequency mode (LFM) with minimum core voltage during desktop idle.	
S0: Maximum value	Highest frequency mode (HFM/Turbo Boost).	The CPU was stressed to its maximum frequency.
S0: Peak value	Highest power spike during the measurement of "S0: Maximum value". This state shows the peak value over a short period of time (worst case power consumption value).	Consider this value when designing the system's power supply to ensure that sufficient power is supplied during worst case scenarios.
S3	SBC is powered by VCC_5V, while in Suspend to RAM state.	
S5	SBC is powered by VCC_5V, while in Soft-Off state	



1. The fan and SATA drives were powered externally.
2. All other peripherals except the LCD monitor were disconnected before measurement.

The tables below provide additional information about the power consumption data for each of the conga-PA5 variants offered. The values are recorded at various operating modes.

Table 8 Power Consumption Values

Part No.	Memory Size	H.W Rev.	BIOS Rev.	OS (64-bit)	CPU			Current (A) @ 12 V				
					Variant	Cores	Base / Burst Freq. (GHz)	S0: Min	S0: Max	S0: Peak	S3	S5
048100	8 GB	A.0	PA50R019	Windows® 10	Atom® x7-E3950	4	1.6/2.0	0.16	1.65	1.88	0.06	0.06
048101	4 GB	A.0	PA50R019	Windows® 10	Atom® x5-E3940	4	1.6/1.8	0.28	1.38	1.46	0.04	0.04
048102	4 GB	A.0	PA50R019	Windows® 10	Atom® x5-E3930	2	1.3/1.8	0.14	0.95	1.06	0.04	0.04
048120	8 GB	A.0	PA50R019	Windows® 10	Pentium® N4200	4	1.1/2.5	0.28	1.15	1.89	0.04	0.03
048121	4 GB	A.0	PA50R019	Windows® 10	Celeron® N3350	2	1.1/2.4	0.29	1.18	1.85	0.04	0.04
048122	4 GB	B.1	PA50R140	Windows® 10	Celeron® J3455	4	1.5/2.3	0.19	1.43	1.79	0.03	0.03
048123	4 GB	A.0	PA50R019	Windows® 10	Pentium® N4200	4	1.1/2.5	0.16	1.05	1.93	0.04	0.03
048110	8 GB	A.0	PA50R019	Windows® 10	Atom® x7-E3950	4	1.6/2.0	0.16	1.65	1.88	0.06	0.06
048111	4 GB	A.0	PA50R019	Windows® 10	Atom® x5-E3940	4	1.6/1.8	0.28	1.38	1.46	0.04	0.04
048112	4 GB	A.0	PA50R019	Windows® 10	Atom® x5-E3930	2	1.3/1.8	0.14	0.95	1.06	0.04	0.04



With fast input voltage rise time, the inrush current may exceed the measured peak current.

2.6 Supply Voltage Battery Power

Table 9 CMOS Battery Power Consumption

RTC @	Voltage	Current
-10°C	3 V DC	1.73 μ A
20°C	3 V DC	1.92 μ A
70°C	3 V DC	3.34 μ A



Note

1. Do not use the CMOS battery power consumption values listed above to calculate CMOS battery lifetime.
2. Measure the CMOS battery power consumption in your customer specific application in worst case conditions (for example, during high temperature and high battery voltage).
3. Consider also the self-discharge of the battery when calculating the lifetime of the CMOS battery. For more information, refer to application note AN9_RTC_Battery_Lifetime.pdf on congatec AG website at www.congatec.com/support/application-notes.
4. We recommend to always have a CMOS battery present when operating the conga-PA5.

2.7 Environmental Specifications

Temperature (commercial variants)	Operation: 0° to 60°C	Storage: -20° to +70°C
Temperature (industrial variants)	Operation: -40° to 85°C	Storage: -40° to +85°C
Humidity	Operation: 10% to 90%	Storage: 5% to 95%



Caution

The above operating temperatures must be strictly adhered to at all times. Humidity specifications are for non-condensing conditions.

3 Block Diagram

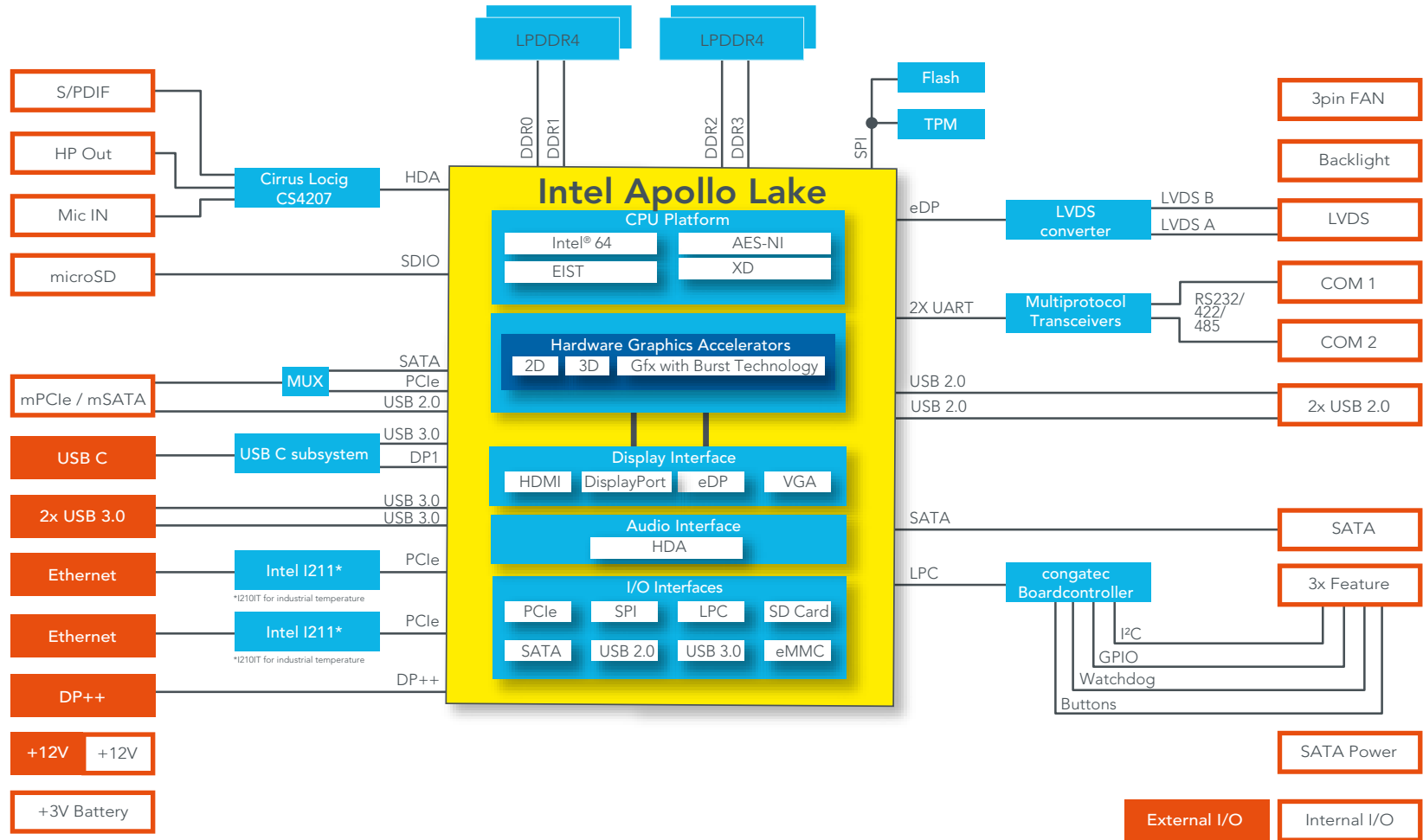

4 Cooling Solutions

congatec AG offers the cooling solutions listed in Table 3 for conga-PA5. The dimensions of the cooling solutions are shown in the sub-sections. All measurements are in millimeters.



Note

1. We recommend a maximum torque of 0.3 Nm for the mounting screws.
2. The gap pad material used on congatec heatspreaders may contain silicon oil that can seep out over time depending on the environmental conditions it is subjected to. For more information about this subject, contact your local congatec sales representative and request the gap pad material manufacturer's specification.



Caution

1. Mount the cooling solution in the correct orientation—the connectors of the conga-PA5 must match the connector names written on the side of the cooling solution. Otherwise, the cooling solution can cause a short on the conga-PA5.
2. The congatec heatspreaders/cooling solutions are tested only within the commercial temperature range of 0° to 60°C. Therefore, if your application that features a congatec heatspreader/cooling solution operates outside this temperature range, ensure the correct operating temperature of the module is maintained at all times. This may require additional cooling components for your final application's thermal solution.
3. For adequate heat dissipation, use the mounting holes on the cooling solution to attach it to the module. Apply thread-locking fluid on the screws if the cooling solution is used in a high shock and/or vibration environment. To prevent the standoff from stripping or cross-threading, use non-threaded carrier board standoffs to mount threaded cooling solutions.
4. For applications that require vertically-mounted cooling solution, use only coolers that secure the thermal stacks with fixing post. Without the fixing post feature, the thermal stacks may move.

4.1 CSP Dimensions

For Lidded Variants

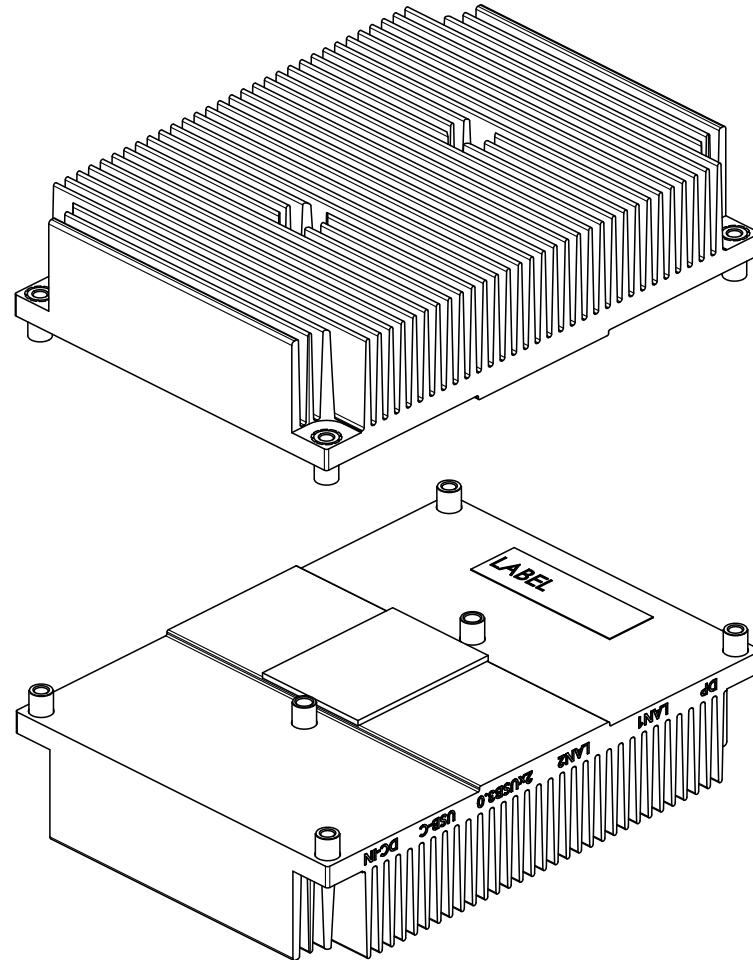
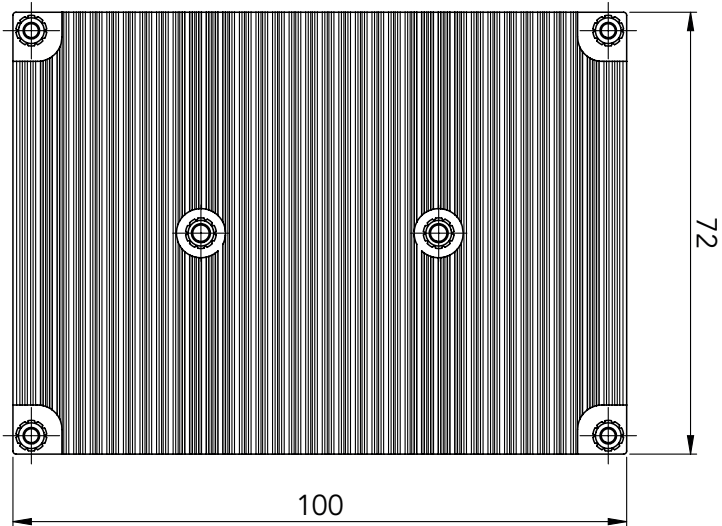
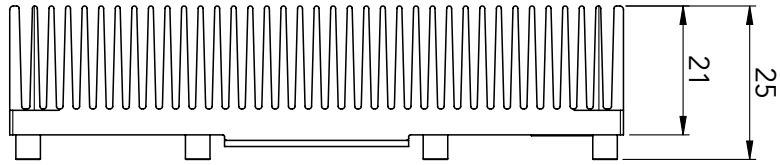

Caution

Mount the cooling solution in the correct orientation—the connectors of the conga-PA5 must match the connector names written on the side of the cooling solution. Otherwise, the cooling solution can cause a short on the conga-PA5.

For Bare-die Variants

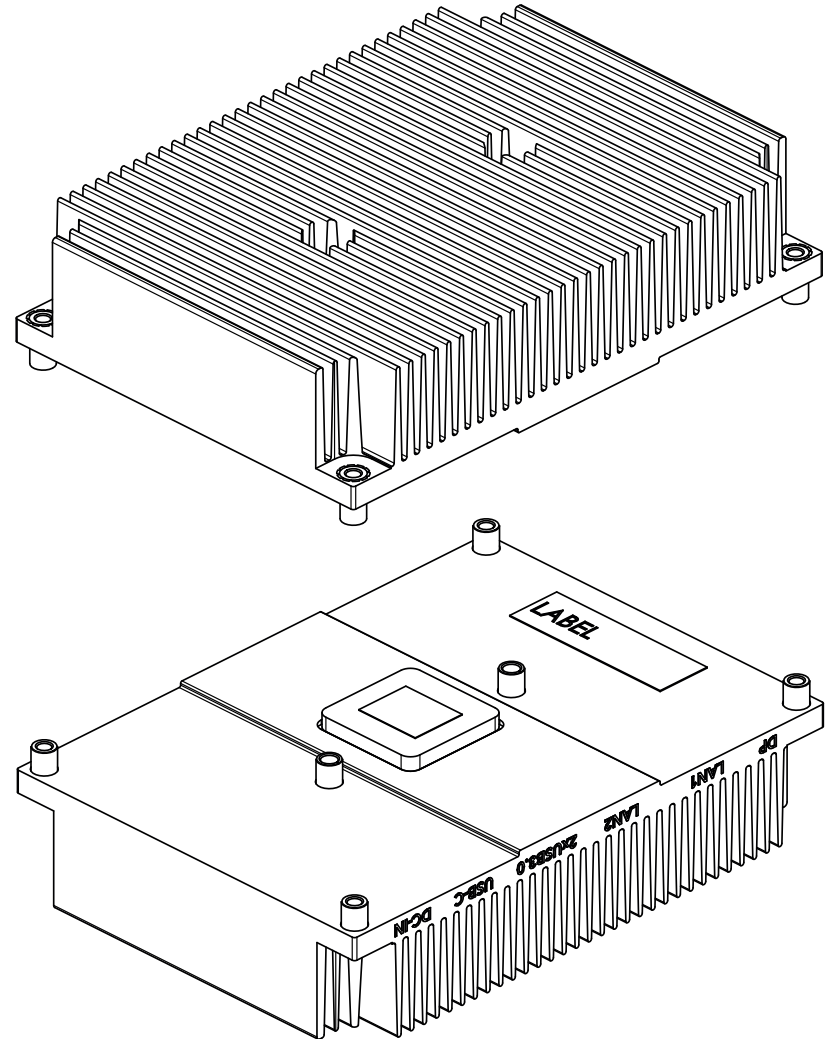
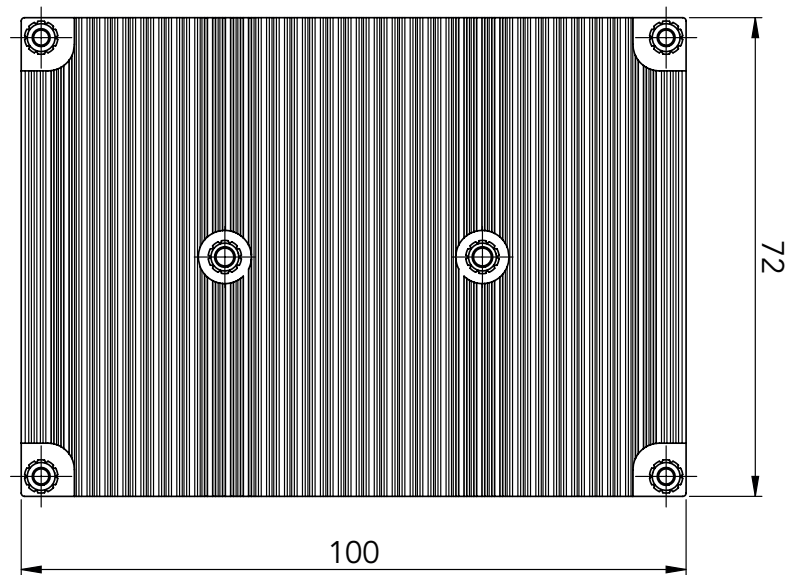
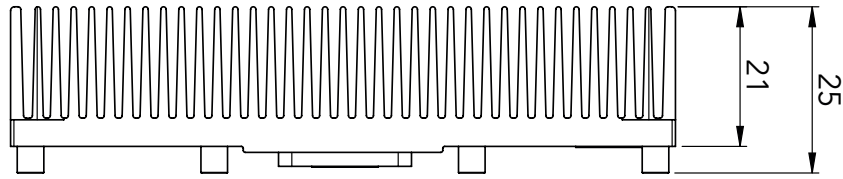



Caution

Mount the cooling solution in the correct orientation—the connectors of the conga-PA5 must match the connector names written on the side of the cooling solution. Otherwise, the cooling solution can cause a short on the conga-PA5.

4.2 HSP Dimensions

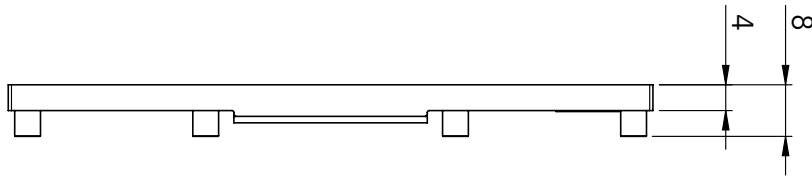
For Lidded Variants



 M2.5 x 8 mm threaded standoff for threaded version
or
ø2.7 x 8 mm non-threaded standoff for borehole version

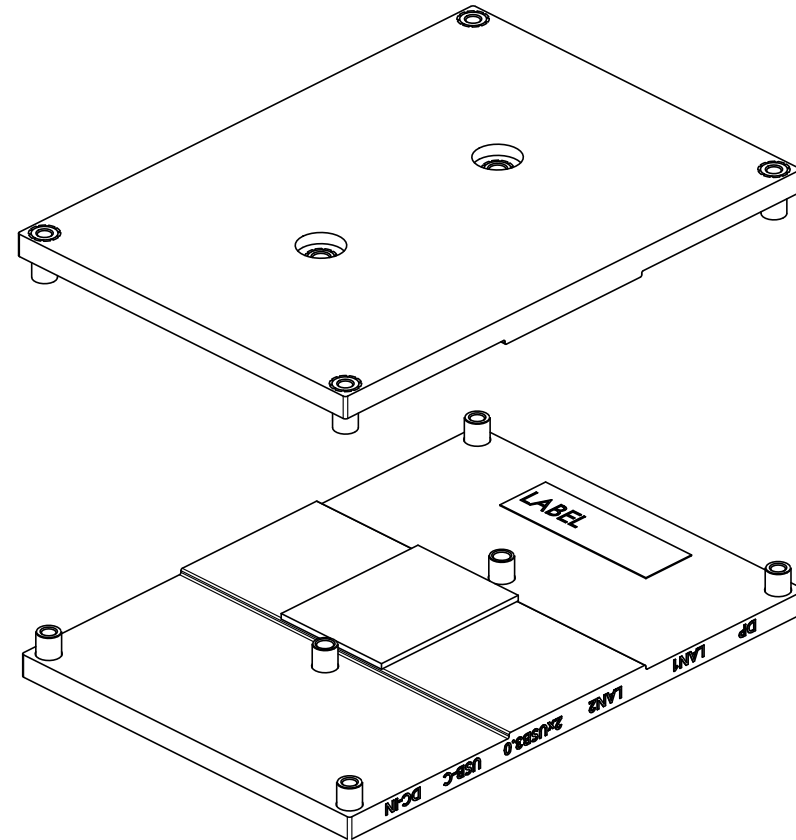
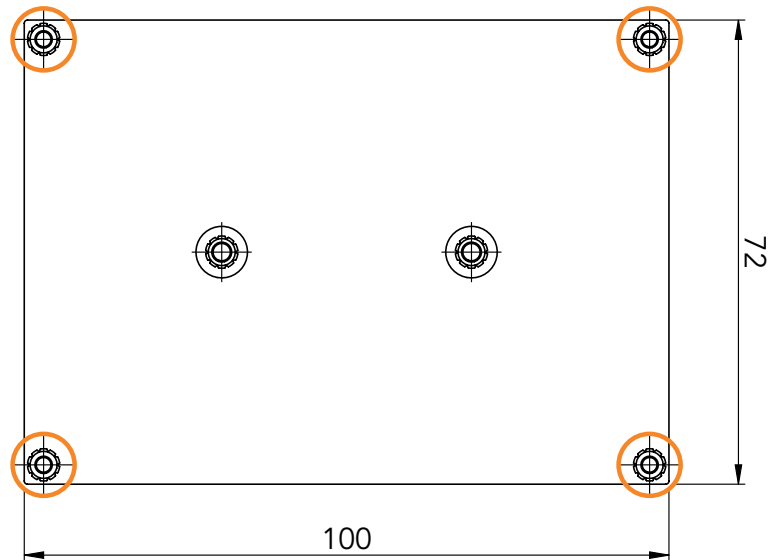

Caution

Mount the cooling solution in the correct orientation—the connectors of the conga-PA5 must match the connector names written on the side of the cooling solution. Otherwise, the cooling solution can cause a short on the conga-PA5.

For Bare-die Variants

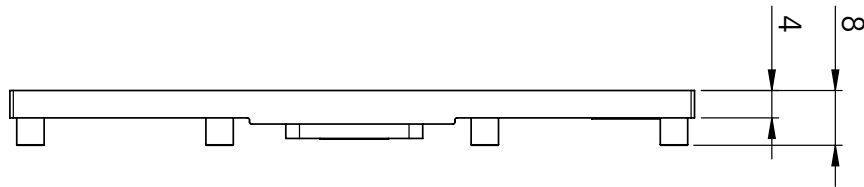

 M2.5 x 8 mm threaded standoff for threaded version
or
ø2.7 x 8 mm non-threaded standoff for borehole version

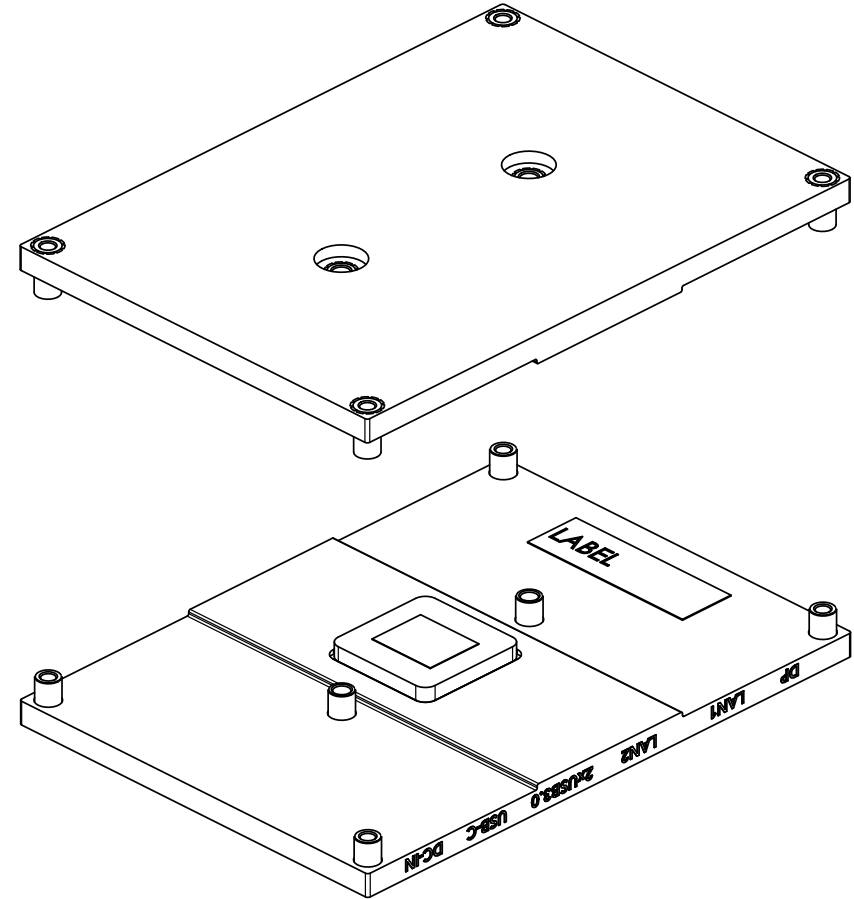
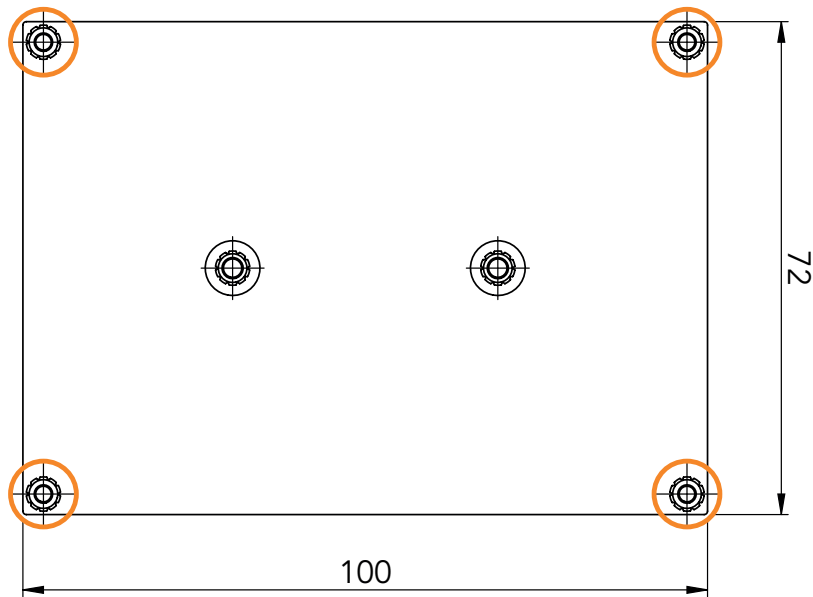

Mount the cooling solution in the correct orientation—the connectors of the conga-PA5 must match the connector names written on the side of the cooling solution. Otherwise, the cooling solution can cause a short on the conga-PA5.

5 Connector Description

5.1 Power Supply Connectors

The conga-PA5 provides a DC power jack (optional for industrial variants), a 2-pin power connector, and a USB Type-C™ port for power supply.

5.1.1 DC Power Jack

The commercial conga-PA5 variants provide a DC power jack (X21), protected against short transient overvoltage and ESD. Optionally, the industrial conga-PA5 variants can also provide a DC power jack. Optionally, congatec can also assemble a DC power jack with locking mechanism, including screw type connectors. The supported power supply is defined in section 2.4 "Supply Voltage Power".

Table 10 X21 Pinout Description

Pin	Function
Center Pin	+12V
Sleeve/Barrel	GND

Connector Type

X21: DC power jack, 5.5x2.5 mm diameter (CUI PJ-002BH)

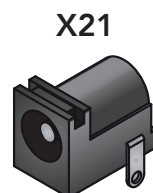

5.1.2 2-Pin Power Connector

The conga-PA5 provides a 2-pin power connector (X22), protected against short transient overvoltage. The supported power supply is defined in section 2.4 "Supply Voltage Power". Alternatively, you can use this connector as a +12V power output.

Table 11 X22 Pinout Description

Pin	Signal	Description
1	+12V	Power Supply +12V
2	GND	Ground

Connector Type

X22: 2x1 pins, 3.00 mm pitch (Molex 43650-0217); Possible Mating Connector: Molex 436450-0200

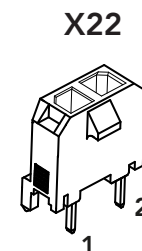

5.1.3 USB Type-C™ Port

The conga-PA5 can be powered via the USB Type-C™ port (X9). The USB power adapter must supply 12V and enough amps for the use case.



Note

Many USB power adapters only supply 5V. The conga-PA5 will not power up if the USB power adapter only supplies 5V.

5.1.4 Power Status LED

The conga-PA5 provides power status LED pins on the feature connector (X18). Refer to section 6.1 "Feature Connectors and Micro-SD Card Slot" for the pinout description.

Table 12 Power Status LED State Description

LED State	Description	ACPI State
Off	Sleeping or power-off (not running)	S3, S5
LED on	Running	S0

5.1.5 CR2032 / BR2330A Cell Battery Header

The conga-PA5 provides a CR2032 cell battery (BR2330A for industrial variants) connected to a header (X23).

Table 13 X23 Pinout Description

Pin	Description
1	+3V
2	GND

X23

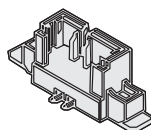

Battery



Connector Type

X23: 2x1 pins, 1.25 mm pitch (Molex 53398-0271); Possible Mating Connector: Molex 15134-0200



Note

The battery has an adhesive tape on its shrinking tube. This tape enables the system integrator to adequately position the battery in the system case. The functionality of adhesive tape is time limited if exposed to higher temperatures and harsh or vibrant environment. The system integrator must ensure a stable position in this case.



Warning

Danger of explosion if battery is incorrectly replaced. Replace only with same or equivalent type recommended by the manufacturer. Dispose of used batteries according to the manufacturer's instructions.

5.2 High Definition Audio Header

The conga-PA5 provides an HD audio header (X6). The signals are routed from an HD audio codec (Cirrus Logic CS4207). Optionally, this header can provide differential Line output (L1) and S/PDIF input.

Table 14 X6 Pinout Description

Pin	Default Signal	Description	Optional Signal
1	MIC_L	Analog Microphone Input - Left Channel	
2	GND_HDA	Audio Ground	
3	MIC_R	Analog Microphone Input - Right Channel	
4	+5V_AMP	+5V Power Supply (for external speaker amplifier; max. 500mA)	
5	MIC_JD	Microphone Jack Detection	
6	HP_R	Headphone Line Out - Right Channel	Line Out L1-
7	GND_HDA	Audio Ground	
8	HP_L	Headphone Line Out - Left Channel	Line Out L1+
9	HP_JD	Headphone Jack Detection	
10	+5V	+5V Power Supply (for S/PDIF optical transmitter)	
11	GND	Digital Ground for S/PDIF	
12	S/PDIF	S/PDIF Output (3.3V)	S/PDIF Input (3.3V)

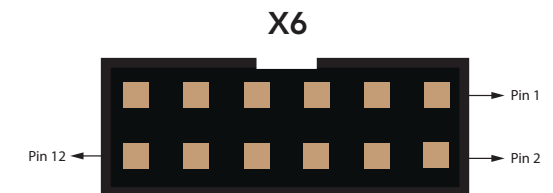

Connector Type

X6: 6x2 pins, 2.0 mm pitch, box header

5.3 USB Connectors

The conga-PA5 provides two USB 3.0 ports, one USB Type-C™ port, and one USB 2.0 header for two additional USB 2.0 ports. USB 2.0 signals are also routed to the mSATA/mPCIe socket (X10).

5.3.1 USB 3.0 Ports

The conga-PA5 provides two USB 3.0 ports (X7).



Connector Type

X7: Dual-stacked USB 3.0 Type-A ports

Upper

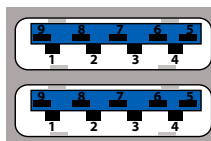

Lower



Caution

The maximum cable length of a USB 2.0 device connected to any port shall not exceed 3 meters in order to comply to EN 55024:2010.

5.3.2 USB Type-C™ Port

The conga-PA5 provides one USB Type-C™ port (X9). It supports Power Delivery (up to 5V @ 3A) and DisplayPort Alternate Mode.



Connector Type

X9: USB Type-C™ port

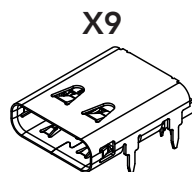

Caution

The maximum cable length of a USB 2.0 device connected to any port shall not exceed 3 meters in order to comply to EN 55024:2010.

5.3.3 USB 2.0 Header

The conga-PA5 provides an USB 2.0 header (X8) for two additional USB 2.0 ports.

Table 15 X8 Pinout Description

Port 1			Port 2		
Pin	Signal	Description	Pin	Signal	Description
1	+5V	+5V supply	2	+5V	+5V supply
3	Data1-	Hi-speed differential signal (negative)	4	Data2-	Hi-speed differential signal (negative)
5	Data1+	Hi-speed differential signal (positive)	6	Data2+	Hi-speed differential signal (positive)
7	GND	Ground	8	GND	Ground
9	SH	Shield Ground	10	SH	Shield Ground

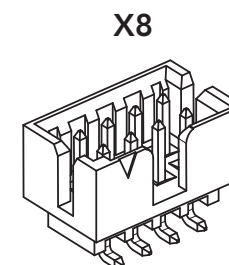

Connector Type

X8: 5x2 pins, 2.00 mm pitch (Molex 87832-1014); Possible Mating Connector: Molex 87568-1063



Caution

The maximum cable length of a USB 2.0 device connected to the header shall not exceed 3 meters in order to comply to EN 55024:2010.

5.4 Gigabit Ethernet Ports

The conga-PA5 provides two Gigabit Ethernet ports (X12, X13). Both ports support Wake-on-LAN (WOL). The signals are routed from the Intel® Gigabit Ethernet controller i211 (commercial variants) or i210 (industrial variants). The controller does not support the Intel® AMT feature.

Table 16 Gigabit Ethernet Port LEDs Description

LED Left Side	Description	LED Right Side	Description
Off	10 Mbps link speed	Off	No link
Green	100 Mbps link speed	Steady On	Link established, no activity detected
Orange	1000 Mbps link speed	Blinking	Link established, activity detected

X12, X13

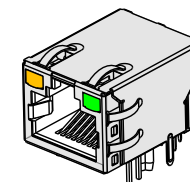

Connector Type

X12, X13: 8-pin RJ45 connector with Gigabit magnetic and LEDs

5.5 SATA Connectors

The conga-PA5 provides a SATA / SATADOM port, a 2-pin SATA power connector and an mSATA/mini PCIe card socket.

5.5.1 SATA / SATADOM Port

The conga-PA5 provides one SATA 6Gb/s port (CN1). To use SATADOM devices with built-in pin 7, enable SATADOM in the BIOS menu. You can connect a SATA activity LED to pin 11 (anode) and 12 (cathode) of the feature connector (X18).



Connector Type

CN1: SATA / SATADOM port

5.5.2 2-Pin SATA Power Connector

The conga-PA5 provides a 5V SATA power connector (X11). The maximum current is limited to 1 A by a fuse.

Table 17 X11 Pinout Description

Pin	Signal
1	+5V (max. 1.0 A)
2	+GND

X11

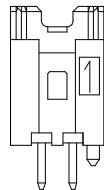

Connector Type

X11: 2x1 pins, 2.50 mm pitch (Molex 53375-0210); Possible Mating Connector: Molex 51103-0200

5.5.3 mSATA Card Slot

The mSATA card slot is described in section 5.9 "mPCIe / mSATA Card Slot".

5.6 Display Interfaces

The conga-PA5 supports up to three displays via one DP++ port, one DP over USB Type-C™ port, and one LVDS header.

5.6.1 DP++ Port

The conga-PA5 provides one DP++ port (X5). The maximum supported resolution is 4096 x 2160 @60 Hz for DP 1.2 and 3840 x 2160 @30 Hz for HDMI 1.4b.

X5

Connector Type

X5: 20 pins, DP++ port

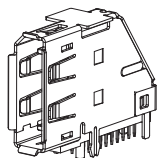

5.6.2 LVDS/eDP Header

The conga-PA5 provides an LVDS header (X3) via an eDP to LVDS bridge by default. It supports 18/24-bit single*/dual channel, selectable backlight voltage, VESA color mappings, automatic panel detection and resolution up to 1920x1200 @60 Hz in dual LVDS mode. Optionally, this header can provide eDP 1.3 with up to 3840x2160 @60 Hz (assembly option).

Table 18 X3 Pinout Description

Pin	Signal	Pin	Signal
1	GND	2	GND
3	LVDS_EVEN_TX3P / eDP_TX3P	4	LVDS_ODD_TX3P
5	LVDS_EVEN_TX3N / eDP_TX3N	6	LVDS_ODD_TX3N
7	GND	8	GND
9	LVDS_EVEN_TX2P / eDP_TX2P	10	LVDS_ODD_TX2P
11	LVDS_EVEN_TX2N / eDP_TX2N	12	LVDS_ODD_TX2N
13	GND	14	GND
15	LVDS_EVEN_TX1P / eDP_TX1P	16	LVDS_ODD_TX1P
17	LVDS_EVEN_TX1N / eDP_TX1N	18	LVDS_ODD_TX1N
19	GND	20	GND
21	LVDS_EVEN_TX0P / eDP_TX0P	22	LVDS_ODD_TX0P
23	LVDS_EVEN_TX0N / eDP_TX0N	24	LVDS_ODD_TX0N
25	GND	26	GND
27	LVDS_EVEN_CLKP / eDP_AUXP	28	LVDS_ODD_CLKP
29	LVDS_EVEN_CLKN / eDP_AUXN	30	LVDS_ODD_CLKN
31	GND	32	GND
33	CGBC_DDC_DAT	34	CGBC_DDC_CLK
35	VCC (+3.3V or +5V, fuse with 1A hold current)	36	VCC (+3.3V or +5V, fuse with 1A hold current)
37	GND	38	VCC (+3.3V or +5V, fuse with 1A hold current)
39	VDDEN	40	eDP_HPD#

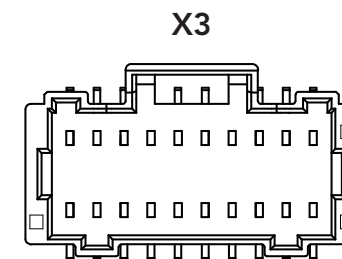

Connector Type

X3: 40 pins, 1.00 mm pitch (Molex 501190-4017); Possible Mating Connector: Molex 501189-4010

Note

* For a single channel LVDS panel, use the ODD pins.

congatec offers an LVDS cable for 17" AUO Optronics G170EG01 V.1 panel only (see section Table 4 "Cables").

5.6.2.1 Backlight Power Header

The conga-PA5 provides a backlight power header (X4). The hold current of the +12 V power is limited to 1.5 A by a fuse.

Table 19 X4 Pinout Description

Pin	Signal	Description
1	+12V	12V Backlight inverter power
2	+12V	12V Backlight inverter power
3	GND	Ground
4	GND	Ground
5	BKLTCTL_5V	Backlight PWM control (+5V)
6	BKLTEN_5V	Backlight Enable (+5V)
7	BKLTEN	Backlight Enable (+3.3V)
8	BKLTCTL	Backlight PWM control (+3.3V)
9	+5V	Optional power rail with +5V (max. 1A)
10	+5V	Optional power rail with +5V (max. 1A)

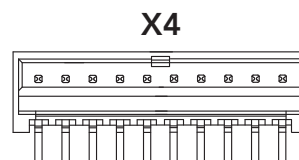

Connector Type

X4: 10x1 pins, 1.5 mm pitch (Molex 87437-1043); Possible Mating Connector: Molex 87439-1000

5.6.2.2 Panel Power Jumper

The conga-PA5 supports 3.3 V and 5 V LVDS panels. Set the panel voltage (pin 35, 36, 38) with jumper X24.

Table 20 X24 Pinout Description

Pin	Signal Name
1 - 2	3.3V
2 - 3	5V

X24



Connector Type

X24: 3x1-pin, 2.00 mm pitch

5.7 COM Headers

The conga-PA5 provides two COM ports (X15, X16) routed from the SoC through a transceiver (ISL3333). Both headers support RS-232, RS-422, and RS-485. You can configure the ports in the BIOS menu.

There are also two options:

- SoC UART Option: The UART port X15 signals can be routed directly from the SoC to the feature connector (X20) instead of GPO[0:3]. With this option, the UART port X15 will not function. This is an assembly option.
- cBC UART Option: A third UART port can be routed from the congatec board controller (cBC) and provided on the feature connector (X20) instead of GPO[0:3]. This is a BIOS switch option.



Caution

The SoC UART signals are 1.8V. If termination is required, a 120Ohm termination must be added externally across pin 4 (RX+) and 5 (RX-).



Note

The UART ports routed from the SoC through the transceiver cannot be used under Windows because Intel® does not provide the necessary driver. They can only be used under Linux. The UART port routed from the cBC can also be used under Windows 10. The driver is available on the congatec website www.congatec.com.

Table 21 X15, X16 Pinout Description

Pin	RS232 Signal	RS422 / RS485 Signal
1	GND	GND
2	TXD	TX-
3	RTS#	TX+
4	CTS#	RX+
5	RXD	RX-

X15, X16

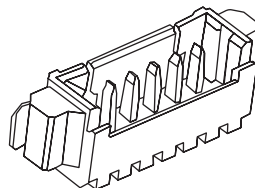

Connector Type

X15, X16: 5x1 pins, 1.25mm pitch (Molex 53261-0519); Possible Mating Connector: Molex 51021-0500



Note

congatec offers adapter cables for the COM ports (see section 1.2.3 "Optional Cables) with and without embedded termination. For more information, contact congatec technical solution department.

5.8 MIPI CSI-2 (Camera)

The conga-PA5 provides a camera interface on connector X1. The interface supports up to two independent cameras – four data lanes for the first camera and two data lanes for the second camera. Each lane operates at up to 1 GT/s depending on the camera resolution. The interfaces follow the MIPI Alliance CSI-2 specification and support up to 24 MP image capture @ 15 fps, full HD 1080p60, YUV420, YUV422, RGB444, RGB555, RGB565, RGB888, JPEG and RAW 8/10/12/14.

The table below shows the conga-PA5 MIPI CSI-2 pinout description. The pinout and voltage levels comply with the SGET Camera Feature Specification.

Table 22 X1 Pinout Description

Pin	Signal	Description
1	CAM_PWR	3.3V +/- 5% supply voltage to power the camera device
2	CAM_PWR	3.3V +/- 5% supply voltage to power the camera device
3	CAM0_CSI_D0+	CSI2 Camera 0 Data Lane 0+
4	CAM0_CSI_D0-	CSI2 Camera 0 Data Lane 0-
5	GND	
6	CAM0_CSI_D1+	CSI2 Camera 0 Data Lane 1+
7	CAM0_CSI_D1-	CSI2 Camera 0 Data Lane 1-
8	GND	
9	CAM0_CSI_D2+	CSI2 Camera 0 Data Lane 2+
10	CAM0_CSI_D2-	CSI2 Camera 0 Data Lane 2-
11	CAM0_RST#	Camera 0 Reset (low active)
12	CAM0_CSI_D3+	CSI2 Camera 0 Data Lane 3+
13	CAM0_CSI_D3-	CSI2 Camera 0 Data Lane 3-
14	GND	
15	CAM0_CSI_CLK+	CSI2 Camera 0 Differential Clock+ (Strobe)
16	CAM0_CSI_CLK-	CSI2 Camera 0 Differential Clock- (Strobe)
17	GND	
18	CAM0_I2C_CLK	Camera 0 Control Interface, CLK
19	CAM0_I2C_DAT	Camera 0 Control Interface, DATA
20	CAM0_ENA#	Camera 0 Enable (low active)
21	MCLK	Master Clock. May be used to drive camera's internal PLL (19.2MHz or 25MHz)
22	CAM1_ENA#	Camera 1 Enable (low active)
23	CAM1_I2C_CLK	Camera 1 Control Interface, CLK

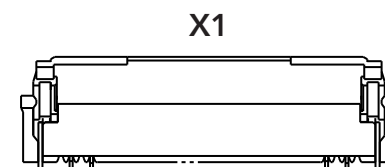

24	CAM1_I2C_DAT	Camera 1 Control Interface, DATA
25	GND	
26	CAM1_CSI_CLK+	CSI2 Camera 1 Differential Clock+ (Strobe)
27	CAM1_CSI_CLK-	CSI2 Camera 1 Differential Clock- (Strobe)
28	GND	
29	CAM1_CSI_D0+	CSI2 Camera 1 Data Lane 0+
30	CAM1_CSI_D0-	CSI2 Camera 1 Data Lane 0-
31	CAM1_RST#	Camera 1 Reset (low active)
32	CAM1_CSI_D1+	N.C.
33	CAM1_CSI_D1-	N.C.
34	GND	
35	CAM0_GPIO	GPIO for Camera 0
36	CAM1_GPIO	GPIO for Camera 1

Connector Type

X1: 36 pins, 0.5mm pitch (Hirose FH12A Series); Possible Mating Connector: I-PEX FAW-1223-T1

Note

The MIPI interface fuse limits the power budget by 750 mA hold current.

5.9 mPCIe / mSATA Card Slot

The conga-PA5 provides an mPCIe / mSATA card slot (X10). A multiplexer detects the type of the connected card via the signal detect pin 43 and sends the corresponding signals to the socket (X10).

Table 23 X10 Pinout Description

Pin	Signal	Pin	Signal
1	WAKE#	2	+3.3V
3	N.C.	4	GND
5	N.C.	6	+1.5V
7	CLKREQ#	8	N.C.
9	GND	10	N.C.
11	REFCLK-	12	N.C.
13	REFCLK+	14	N.C.
15	GND	16	N.C.
17	N.C.	18	GND
19	N.C.	20	W_DISABLE#
21	GND	22	PERST#
23	PERn0/SATA_RX1+	24	+3.3V
25	PERp0/SATA_RX1-	26	GND
27	GND	28	+1.5V
29	GND	30	SMB_CLK
31	PETn0/SATA_TX1-	32	SMB_DATA
33	PETp0/SATA_TX1+	34	GND
35	GND	36	USB_D-
37	GND	38	USB_D+
39	+3.3V	40	GND
41	+3.3V	42	N.C
43	mSATA_mPCIe_detect	44	LED_WLAN#
45	N.C	46	N.C
47	N.C	48	+1.5V
49	N.C	50	GND
51	N.C.	52	+3.3V
53	GND	54	GND

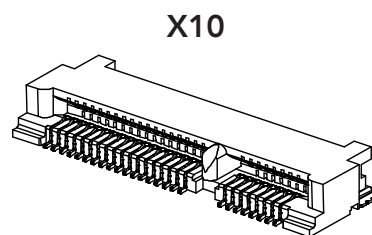

Note

Pin 43 of mPCIe cards must be connected to ground.

Pin 43 of mSATA cards must NOT be connected to ground.

The mPCIe extender can be used for mPCIe half size cards.

Connector Type

X10: mPCIe / mSATA card slot

6 Additional Features

6.1 Feature Connectors and Micro-SD Card Slot

The conga-PA5 provides three feature connectors and a micro-SD card slot.

6.1.1 Buttons and LEDs

The conga-PA5 offers lid, sleep, reset, power buttons as well as LED signals via the feature connector X18.

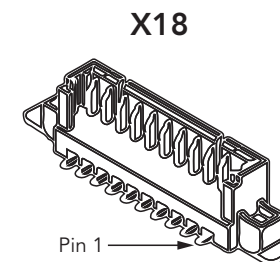

Table 24 X18 Pinout Description

Pin	Signal Name	Description	Comments
1	LID_BTN#	Active-low signal brings the system into sleep state or wakes it up.	Requires an ACPI compatible operating system.
2	GND	Ground	
3	SLP_BTN#	Active-low signal triggers sleep state.	
4	GND	Ground	
5	RST_BTN#	Active-low signal triggers hard reset.	Does not keep the system in reset when connected to ground.
6	GND	Ground	
7	PWR_BTN#	Active-low signal triggers power-up sequence. Pulse duration of ≥ 4 seconds triggers forced shutdown.	Signal can also be triggered by the cBC depending on BIOS settings (see section 6.2.2 "Power Loss Control").
8	GND	Ground	
9	PWR_LED (anode)	LED is on if the system is powered on.	
10	GND (cathode)	LED is on if the system is powered on.	
11	SATA_LED (anode)	LED indicates activity on the SATA port CN1 and/or mSATA.	
12	SATA_ACT# (cathode)	LED indicates activity on the SATA port CN1 and/or mSATA.	

Connector Type

X18: 12x1 pins, 1.25 mm pitch (Molex 53398-1271); Possible Mating Connector: Molex 51021-1200

Note

The LEDs on the conga-PA5 are supplied by +3.3 V with 330Ohm series resistors. You can connect X18 pins directly to the LED terminals. The buttons are edge triggered with 16 ms debouncing and can be directly connected to a tactile switch or OC output. A typical pulse duration takes up to one second.

6.1.2 I2C and Watchdog

The conga-PA5 provides I2C and watchdog signals via the feature connector X19. Optionally, this connector can provide pins for SMBus and power states.

Table 25 X19 Pinout Description

Pin	Default Signal	Description	Comments	Option	Description
1	BATLOW#	Battery Low	Active-low signal indicates low external battery. Input with PU to +3.3V, connect to OC output.		
2	+3.3V	+3.3VDC Power Supply			
3	LED_WLAN# (mPCIe)	WLAN LED for mPCIe	Connect cathode of LED. LED is on when WLAN is on.	SMB_ALERT#	SMBus Alert input
4	I2C_CLK	I2C Clock line	External PU/PD not required. +3.3V standby powered.	SMB_CLK	SMBus Clock line
5	I2C_DAT	I2C Data line	External PU/PD not required. +3.3V standby powered.	SMB_DAT	SMBus Data line
6	GND	Ground			
7	WDTRIG#	Active-low signal resets system watchdog timer and prevents watchdog event.	External PU/PD not required. +3.3V runtime powered. Input signal for module. Should be driven by open collector output.	SLP_S3#	Power state pin
8	WDOUT	High active signal means watchdog event is triggered.	+3.3V output with PD.	SLP_S4#	Power state pin

Connector Type

X19: 8x1 pins, 1.25 mm pitch (Molex 53398-0871); Possible Mating Connector: Molex 51021-0800

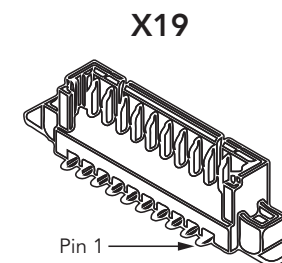

Note

The signals are 3.3V compatible. A fuse limits the 3.3V power budget of connector X19 (pin 2) and X20 (pin 10) to a total of 500 mA hold current. LED_WLAN# shall be connected to the LED's cathode. A series resistor is present on conga-PA5.

6.1.3 GPIOs

The conga-PA5 provides GPIOs via the feature connector X20. Optionally, it can provide a connection to the integrated sensor hub (ISH) of the SoC, an UART port from the SoC, or an UART port from the cBC in addition to GbE signals. See section 5.7 "COM Headers" for more information.

Table 26 X20 Pinout Description

Pin	Default Signal	ISH Option	SoC UART Option	BIOS Switch Option
1	GPI0 (+3.3V)	ISH_GPIO4 (+1.8V)		GbE1_SDP0
2	GPI1 (+3.3V)	ISH_GPIO5 (+1.8V)		GbE1_SDP1
3	GPI2 (+3.3V)	ISH_I2C0_SDA (+1.8V)		GbE2_SDP0
4	GPI3 (+3.3V)	ISH_I2C0_SCL (+1.8V)		GbE2_SDP1
5	GND	GND	GND	GND
6	GPO0 (+3.3V)	ISH_GPIO6 (+1.8V)	UART1_TXD (+1.8V)	BC_UART_TXD (+3.3V)
7	GPO1 (+3.3V)	ISH_GPIO7 (+1.8V)	UART1_RTS# (+1.8V)	BC_UART_RTS# (+3.3V)
8	GPO2 (+3.3V)	ISH_I2C1_SDA (+1.8V)	UART1_CTS# (+1.8V)	BC_UART_CTS# (+3.3V)
9	GPO3 (+3.3V)	ISH_I2C1_SCL (+1.8V)	UART1_RXD# (+1.8V)	BC_UART_RXD# (+3.3V)
10	+3.3V	+3.3V	+3.3V	+3.3V

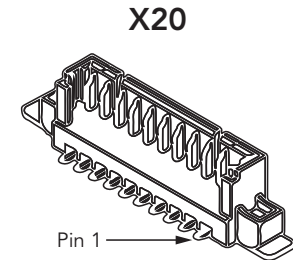

Connector Type

X20: 10x1 pins, 1.25 mm pitch (Molex 53398-1071); Possible Mating Connector: Molex 51021-1000

Note

A fuse limits the 3.3V power budget of connector X19 (pin 2) and X20 (pin 10) to a total of 500 mA hold current.

Caution

The optional ISH and SoC UART signals routed directly from the SoC are 1.8V.

6.1.4 Micro-SD Card Slot

The conga-PA5 provides a micro-SD card slot (X14). It complies with SDXC card specification 3.0 with support for up to 104 MB/s data rate.



Connector Type

X14: Micro-SD card slot

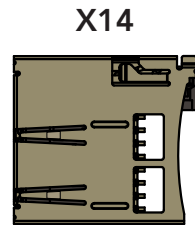

6.2 congatec Board Controller (cBC)

The conga-PA5 is equipped with a Texas Instruments Tiva™ TM4E1231H6ZRBI microcontroller. This onboard microcontroller plays an important role for most of the congatec BIOS features. The cBC fully isolates some of the embedded features such as system monitoring, I²C bus from the x86 core architecture. This improves performance and reliability, even during low power mode.

6.2.1 Fan Control

The congatec Board Controller on the conga-PA5 controls the power supply to the fan with the PWM signal. Additionally, there is an input signal called FAN_TACHOIN that provides the ability to monitor the system's fan RPMs (revolutions per minute). This signal must receive two pulses per revolution in order to produce an accurate reading. For this reason, a two pulse per revolution fan is recommended.

6.2.2 Power Loss Control

The cBC has full control of the power-up of the SBC. Therefore, it can be used to specify the behavior of the system after an AC power loss condition. Supported modes are "Turn On", "Remain Off" and "Last State".

6.2.3 Board Information

The cBC provides a rich data-set of manufacturing and board information such as serial number, EAN number, hardware and firmware revisions, and so on. It also keeps track of dynamically changing data like runtime meter and boot counter.

6.2.4 CPU Fan Header

The conga-PA5 provides a 3-pin 12V CPU fan header (X17). The recommended maximum power of the fan is 3W.

Table 27 X17 Pinout Description

Pin	Signal
1	GND
2	+12VDC
3	FAN_TACHOIN

X17



Connector Type

X17: 3x1 pins, 2.54 mm pitch (Molex 22-27-2031); Possible Mating Connector: Molex 22-01-2025

6.3 OEM BIOS Customization

The conga-PA5 is equipped with congatec Embedded BIOS, which is based on American Megatrends Inc. Aptio UEFI firmware. The congatec Embedded BIOS allows system designers to modify the BIOS. For more information about customizing the congatec Embedded BIOS, refer to the congatec System Utility user's guide CGUTLm1x.pdf and can be found on the congatec website or contact technical support.

The customization features supported are described in the following sections.

6.3.1 OEM Default Settings

This feature allows system designers to create and store their own BIOS default configuration. Customized BIOS development by congatec for OEM default settings is no longer necessary because customers can easily perform this configuration by themselves using the congatec system utility CGUTIL. See congatec application note AN8_Create_OEM_Default_Map.pdf on the congatec website for details on how to add OEM default settings to the congatec Embedded BIOS.

6.3.2 OEM Boot Logo

This feature allows system designers to replace the standard text output displayed during POST with their own BIOS boot logo. Customized BIOS development by congatec for OEM Boot Logo is no longer necessary because customers can easily perform this configuration by themselves using the congatec system utility CGUTIL. See congatec application note AN8_Create_And_Add_Bootlogo.pdf on the congatec website for details on how to add OEM boot logo to the congatec Embedded BIOS.

6.3.3 OEM POST Logo

This feature allows system designers to replace the congatec POST logo displayed in the upper left corner of the screen during BIOS POST with their own BIOS POST logo. Use the congatec system utility CGUTIL 1.5.4 or later to replace/add the OEM POST logo.

6.3.4 OEM BIOS Code/Data

With the congatec embedded BIOS, it is possible for system designers to add their own code to the BIOS POST process. The congatec Embedded BIOS first calls the OEM code before handing over control to the OS loader. Except for custom specific code, this feature can also be used to support Win XP SLP installation, Window 7 SLIC table (OA2.0), Windows 8 OEM activation (OA3.0), verb tables for HDA codecs, PCI/PCIe opROMs, bootloaders, rare graphic modes and Super I/O controller initialization.



The OEM BIOS code of the new UEFI based firmware is only called when the CSM (Compatibility Support Module) is enabled in the BIOS setup menu. Contact congatec technical support for more information on how to add OEM code.

6.3.5 OEM DXE Driver

This feature allows designers to add their own UEFI DXE driver to the congatec embedded BIOS. Contact congatec technical support for more information on how to add an OEM DXE driver.

6.4 congatec Battery Management Interface

In order to facilitate the development of battery powered mobile systems based on embedded modules, congatec AG has defined an interface for the exchange of data between a CPU module (using an ACPI operating system) and a Smart Battery system. A system developed according to the congatec Battery Management Interface Specification can provide the battery management functions supported by an ACPI capable operating system (e.g. charge state of the battery, information about the battery, alarms/events for certain battery states, ...) without the need for any additional modifications to the system BIOS. In addition to the ACPI-Compliant Control Method Battery mentioned above, the latest versions of the conga-PA5 BIOS and board controller firmware also support LTC1760 battery manager from Linear Technology and a battery only solution (no charger). All three battery solutions are supported on the I2C bus and the SMBus. This gives the system designer more flexibility when choosing the appropriate battery sub-system.

For more information about this subject visit the congatec website and view the following documents:

- congatec Battery Management Interface Specification
- Battery System Design Guide
- conga-SBM³ User's Guide

6.5 API Support (CGOS)

In order to benefit from the above mentioned non-industry standard feature set, congatec provides an API that allows application software developers to easily integrate all these features into their code. The CGOS API (congatec Operating System Application Programming Interface) is the congatec proprietary API that is available for all commonly used Operating Systems such as Win32, Win64, Win CE, Linux. The architecture of the CGOS API driver provides the ability to write application software that runs unmodified on all congatec CPU modules. All the hardware related code is contained within the congatec embedded BIOS on the module. See section 1.1 of the CGOS API software developers guide, which is available on the congatec website.

6.6 GPIOs

The conga-PA5 SBC provides four GPIs and four GPOs via the congatec board controller. The GPI/GPO signals are routed to the feature connector X20.

6.7 Thermal/Voltage Monitoring

The CPU onboard the conga-PA5 monitors the system temperature while the congatec Board Controller monitors the +12V input voltage and input current.

6.8 External System Wake Event

The conga-PA5 supports LAN, power/sleep/LID buttons and PCIe driven wake up events.

6.9 Security Features

The conga-PA5 has an integrated Intel® PTT (TPM 2.0). Additionally, an Infineon SLB9670 (LPC TPM 2.0) is assembled.



You can enable/disable the integrated Intel® PTT (TPM 2.0) in BIOS Setup: Enter BIOS Setup (see section 8.1 "Navigating the BIOS Setup Menu"), navigate to "Advanced Setup" and then "Platform Trust Technology". Always disable fTPM if you use an external TPM.

7 Mechanical Drawing

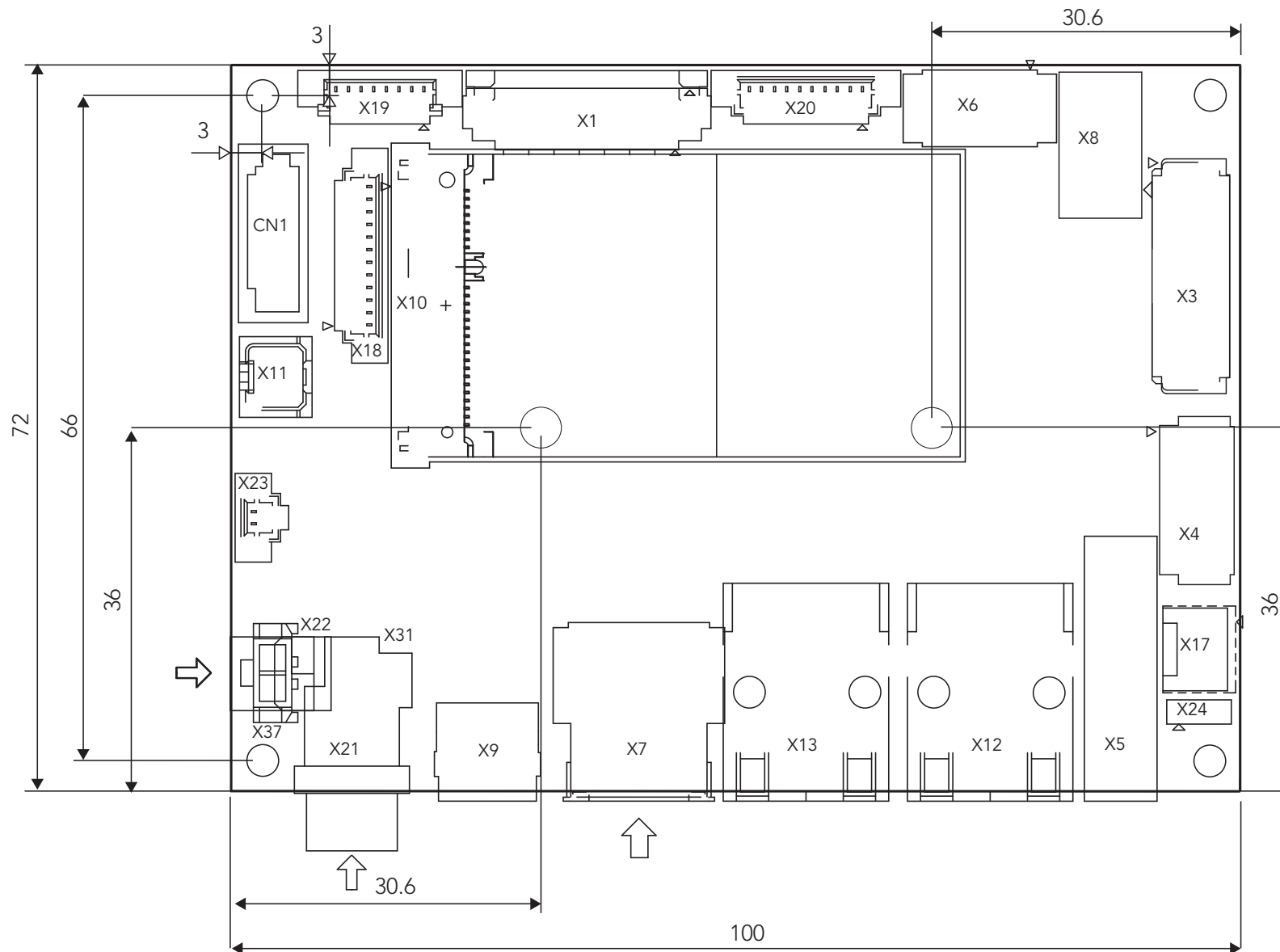

8 BIOS Setup Description

The BIOS setup description of the conga-PA5 can be viewed without having access to the SBC. However, access to the restricted area of the congatec website is required in order to download the necessary tool (CgMlfViewer) and Menu Layout File (MLF).

The MLF contains the BIOS setup description of a particular BIOS revision. The MLF can be viewed with the CgMlfViewer tool. This tool offers a search function to quickly check for supported BIOS features. It also shows where each feature can be found in the BIOS setup menu.

For more information, read the application note "AN42 - BIOS Setup Description" available at www.congatec.com.



Note

If you do not have access to the restricted area of the congatec website, contact your local congatec sales representative.

8.1 Navigating the BIOS Setup Menu

The BIOS setup menu shows the features and options supported in the congatec BIOS. To access and navigate the BIOS setup menu, press the or <F2> key during POST.

The right frame displays the key legend. Above the key legend is an area reserved for text messages. These text messages explain the options and the possible impacts when changing the selected option in the left frame.

8.2 BIOS Versions

The BIOS displays the BIOS project name and the revision code during POST, and on the main setup screen. The initial production BIOS for conga-PA5 is identified as PA50R1xx, where:

- PA5 is the project name
- R is the identifier for a BIOS ROM file
- 1 is the feature number
- xx is the major and minor revision number.

The binary size of conga-PA5 BIOS is 8MB.

8.3 Updating the BIOS

BIOS updates are recommended to correct platform issues or enhance the feature set of the SBC. The conga-PA5 features a congatec/AMI AptioEFI firmware on an onboard flash ROM chip. You can update the firmware with the congatec System Utility. The utility has five versions—UEFI shell, DOS based command line¹, Win32 command line, Win32 GUI, and Linux version.

For more information about “Updating the BIOS” refer to the user’s guide for the congatec System Utility “CGUTLm1x.pdf” on the congatec website at www.congatec.com.



Note

¹. *Deprecated*



Caution

The DOS command line tool is not officially supported by congatec and therefore not recommended for critical tasks such as firmware updates. We recommend to use only the UEFI shell for critical updates.

8.4 Supported Flash Device

The conga-PA5 supports flash device Winbond W25Q64JVSSIQ (8MB). For more information about external BIOS support, refer to the Application Note “AN7_External_BIOS_Update.pdf” on the congatec website at www.congatec.com.

9 Industry Specifications

Table 28 References

Specification	Link
Universal Serial Bus (USB) Specification, Revision 2.0	www.usb.org
Serial ATA Specification, Revision 3.0	www.serialata.org
PCI Express Base Specification, Revision 2.0	www.pcisig.com/specifications

Our company network supports you worldwide with offices in Germany, Austria, Switzerland, the UK and the USA. For more information please contact:

Headquarters



<p>Germany</p> 		<p>FORTEC Elektronik AG Augsburger Str. 2b 82110 Germering</p>	<p>Phone: +49 89 894450-0 E-Mail: info@fortecaq.de Internet: www.fortecaq.de</p>
--------------------------------------------------------------------------------------------------	-----------------------------------------------------------------------------------	-------------------------------------------------------------------------------	---------------------------------------------------------------------------------------------------------------------------------------------------------------------

Fortec Group Members

<p>Austria</p> 	 <p>A FORTEC GROUP MEMBER</p>	<p>Distec GmbH, Office Vienna Nuschinggasse 12 1230 Wien</p>	<p>Phone: +43 1 8673492-0 E-Mail: info@distec.de Internet: www.distec.de</p>
--------------------------------------------------------------------------------------------------	----------------------------------------------------------------------------------------------------------------	---------------------------------------------------------------------------------	-------------------------------------------------------------------------------------------------------------------------------------------------------------

<p>Germany</p> 	 <p>A FORTEC GROUP MEMBER</p>	<p>Distec GmbH Augsburger Str. 2b 82110 Germering</p>	<p>Phone: +49 89 894363-0 E-Mail: info@distec.de Internet: www.distec.de</p>
--------------------------------------------------------------------------------------------------	----------------------------------------------------------------------------------------------------------------	----------------------------------------------------------------------	-------------------------------------------------------------------------------------------------------------------------------------------------------------

<p>Switzerland</p> 	 <p>A FORTEC GROUP MEMBER</p>	<p>ALTRAC AG Bahnhofstraße 3 5436 Würenlos</p>	<p>Phone: +41 44 7446111 E-Mail: info@altrac.ch Internet: www.altrac.ch</p>
-------------------------------------------------------------------------------------------------------	-----------------------------------------------------------------------------------------------------------------	---------------------------------------------------------------	------------------------------------------------------------------------------------------------------------------------------------------------------------

<p>United Kingdom</p> 	 <p>A FORTEC GROUP MEMBER</p>	<p>Display Technology Ltd. Osprey House, 1 Osprey Court Hichingbrooke Business Park Huntingdon, Cambridgeshire, PE29 6FN</p>	<p>Phone: +44 1480 411600 E-Mail: info@displaytechnology.co.uk Internet: www.displaytechnology.co.uk</p>
-----------------------------------------------------------------------------------------------------------	------------------------------------------------------------------------------------------------------------------	-------------------------------------------------------------------------------------------------------------------------------------------------	---------------------------------------------------------------------------------------------------------------------------------------------------------------------------------------------------------------------

<p>USA</p> 	 <p>A FORTEC GROUP MEMBER</p>	<p>Apollo Display Technologies, Corp. 87 Raynor Avenue, Unit 1 Ronkonkoma, NY 11779</p>	<p>Phone: +1 631 5804360 E-Mail: info@apolloDisplays.com Internet: www.apolloDisplays.com</p>
------------------------------------------------------------------------------------------------	------------------------------------------------------------------------------------------------------------------	------------------------------------------------------------------------------------------------------------	------------------------------------------------------------------------------------------------------------------------------------------------------------------------------------------------